

PROJECT PRICE LIST 2026

EFFECTIVE APRIL 2026



ABOUT US

IndoAsian, an Indian-origin brand **established in 1958**, has been a pioneer in electrical safety and innovation, trusted for delivering reliable, high quality solutions that empower homes, businesses, and communities.

With industry leading milestones such as introducing **6kA MCBs and RCCBs in India**, the brand has consistently set new standards in protection and performance. Its association with Group Legrand India further strengthened its innovation capabilities and expanded its reach, allowing IndoAsian to offer world class electrical and digital infrastructure.

Guided by the motto “**Enriching quality of life by ensuring safe, efficient and convenient use of electricity,**” the brand continues to uphold strong values, customer first innovation, and ethical, sustainable practices focused on **renewable energy and reducing environmental impact.**



CONTENT

—optipro—	MINIATURE CIRCUIT BREAKER (MCBS)	04-11
—optipro—	AC CIRCUIT BREAKER	12
—optipro—	DC CIRCUIT BREAKER	13
—optipro—	DC MCB WITH EXTENDED LINK AS PER RDSO	14
—optipro—	ISOLATOR	15
—optipro—	RESIDUAL CURRENT CIRCUIT BREAKER (RCCBS)	16
—optipro—	RCD ADD ON BLOCK	17
—optipro—	ACCESSORIES	18
—optipro—	DISTRIBUTION BOARDS (DBS)	19-29
	BUSBAR CHAMBER	30-31
	TIME SWITCHES	32
	TIMELITE DISTRIBUTION BOARDS	33
	AUTOMATIC CHANGEOVER WITH CURRENT LIMITER (ACCL)	34
—optium—	MCCB - 1.0 (FIXED TM RANGE)	35-39
—optium—	MCCB - 1.1 (FIXED TM RANGE)	40
—optium—	MCCB - 2.0 (ADJUSTABLE TM RANGE)	41-44
—optium—	MCCB - 2.1 (ELECTRONIC RANGE)	45
—optium—	MCCB - 2.2 (ELECTRONIC RANGE WITH GROUND FAULT SETTING)	46
—optium—	MCCB ACCESSORIES	47-50
—optipro—	SMDB	51-60
—optinova—	SWITCH DISCONNECTOR / TSE (ON LOAD CHANGEOVER)	61-64
	HRC FUSE LINKS & BASES	65-66
	SWITCH DISCONNECTOR FUSES	67-68
	Ambidex CHANGEOVER SWITCHES	69-71
	Shynora WIRING ACCESSORIES	72-85
	Glint™ WIRING ACCESSORIES	86-92
	ELVIRA WIRING ACCESSORIES	93-99
	Doorsta DING DONG DOORBELL	100-101
	PL9 PLUGS	101
	Zosta™ EXHAUST FANS	102-103
	BULB HOLDER / CEILING ROSE	104-105

Engineered to perfection with a wide range and unmatched quality



Scan to know more about the product

Optipro MCBs are designed to provide protection for circuits in residential, commercial & industrial installations. These ranges safeguard electrical systems from overloads and short circuits.

Features

- Designed to perform in extreme conditions
- Visual status window (Red-ON/Green-OFF) for contact position
- Bi connect terminal with large terminal size

Benefits

- Protects against Overload and Short Circuit
- Simple clip-on mechanism that allows for quick and easy installation
- IP 20 degree protection ensures no live parts are exposed

—optipro™—

Miniature Circuit Breaker-MCB

• Conforms to IS/IEC 60898-1 • Short-Circuit Breaking Capacity 10kA • Line Load Reversibility • Large Terminal Size -35sqmm • Biconnect Terminals • Clear Visual Indication of Contact Position

B Curve Single Pole

HSN Code: 8536



Rating (A)	Pack	Cat. Nos.	MRP ₹ / Unit
6	1/12/180	811008	317
10	1/12/180	811010	317
16	1/12/180	811012	317
20	1/12/180	811013	317
25	1/12/180	811014	317
32	1/12/180	811015	317
40	1/12/180	811016	736
50	1/12/180	811017	851
63	1/12/180	811018	851

B Curve Single Pole Neutral

HSN Code: 8536



Rating (A)	Pack	Cat. Nos.	MRP ₹ / Unit
6	1/6/90	811027	1082
10	1/6/90	811029	1082
16	1/6/90	811031	1082
20	1/6/90	811032	1082
25	1/6/90	811033	1082
32	1/6/90	811034	1082
40	1/6/90	811035	1528
50	1/6/90	811036	1733
63	1/6/90	811037	1733

—optipro™—

B Curve Double Pole

HSN Code: 8536



811046

811048

Rating (A)	Pack	Cat. Nos.	MRP ₹ / Unit
6	1/6/90	811046	1124
10	1/6/90	811048	1124
16	1/6/90	811050	1124
20	1/6/90	811051	1124
25	1/6/90	811052	1124
32	1/6/90	811053	1124
40	1/6/90	811054	1635
50	1/6/90	811055	1821
63	1/6/90	811056	1821

C Curve Single Pole

HSN Code: 8536



811114

811115

Rating (A)	Pack	Cat. Nos.	MRP ₹ / Unit
0.5	1/12/180	811114	573
1	1/12/180	811115	573
2	1/12/180	811117	573
3	1/12/180	811119	573
4	1/12/180	811120	573
5	1/12/180	811121	573
6	1/12/180	811122	329
10	1/12/180	811124	329
16	1/12/180	811126	329
20	1/12/180	811127	329
25	1/12/180	811128	329
32	1/12/180	811129	329
40	1/12/180	811130	695
50	1/12/180	811131	813
63	1/12/180	811132	813

—optipro™—

C Curve Single Pole Neutral

HSN Code: 8536

	Rating (A)	Pack	Cat. Nos.	MRP ₹ / Unit
 <p>811136 811137</p>	0.5	1/6/90	811136	1198
	1	1/6/90	811137	1198
	2	1/6/90	811139	1198
	3	1/6/90	811141	1198
	4	1/6/90	811142	1198
	5	1/6/90	811143	1198
	6	1/6/90	811144	1115
	10	1/6/90	811146	1115
	16	1/6/90	811148	1115
	20	1/6/90	811149	1115
	25	1/6/90	811150	1115
	32	1/6/90	811151	1115
	40	1/6/90	811152	1589
	50	1/6/90	811153	1791
	63	1/6/90	811154	1791

C Curve Double Pole

HSN Code: 8536

	Rating (A)	Pack	Cat. Nos.	MRP ₹ / Unit
 <p>811158 811159</p>	0.5	1/6/90	811158	1372
	1	1/6/90	811159	1372
	2	1/6/90	811161	1372
	3	1/6/90	811163	1372
	4	1/6/90	811164	1372
	5	1/6/90	811165	1372
	6	1/6/90	811166	1135
	10	1/6/90	811168	1135
	16	1/6/90	811170	1135
	20	1/6/90	811171	1135
	25	1/6/90	811172	1135
	32	1/6/90	811173	1135
	40	1/6/90	811174	1693
	50	1/6/90	811175	1866
	63	1/6/90	811176	1866

—optipro™—

C Curve Three Pole

HSN Code: 8536

	Rating (A)	Pack	Cat. Nos.	MRP ₹ / Unit
 <p>811180</p>	0.5	1/4/60	811180	2107
	1	1/4/60	811181	2107
	2	1/4/60	811183	2107
	3	1/4/60	811185	2107
	4	1/4/60	811186	2107
	5	1/4/60	811187	2107
	6	1/4/60	811188	1773
	10	1/4/60	811190	1773
	16	1/4/60	811192	1773
	20	1/4/60	811193	1773
	25	1/4/60	811194	1773
	32	1/4/60	811195	1773
	40	1/4/60	811196	2620
	50	1/4/60	811197	2744
	63	1/4/60	811198	2744

C Curve Three Pole Neutral

HSN Code: 8536

	Rating (A)	Pack	Cat. Nos.	MRP ₹ / Unit
 <p>811202</p>	0.5	1/3/45	811202	2704
	1	1/3/45	811203	2704
	2	1/3/45	811205	2704
	3	1/3/45	811207	2704
	4	1/3/45	811208	2704
	5	1/3/45	811209	2704
	6	1/3/45	811210	2306
	10	1/3/45	811212	2306
	16	1/3/45	811214	2306
	20	1/3/45	811215	2306
	25	1/3/45	811216	2306
	32	1/3/45	811217	2306
	40	1/3/45	811218	3101
	50	1/3/45	811219	3282
	63	1/3/45	811220	3282

—optipro™—

C Curve Four Pole

HSN Code: 8536



811224

Rating (A)	Pack	Cat. Nos.	MRP ₹ / Unit
0.5	1/3/45	811224	2746
1	1/3/45	811225	2746
2	1/3/45	811227	2746
3	1/3/45	811229	2746
4	1/3/45	811230	2746
5	1/3/45	811231	2746
6	1/3/45	811232	2531
10	1/3/45	811234	2531
16	1/3/45	811236	2531
20	1/3/45	811237	2531
25	1/3/45	811238	2531
32	1/3/45	811239	2531
40	1/3/45	811240	3469
50	1/3/45	811241	3546
63	1/3/45	811242	3546

D Curve Single Pole

HSN Code: 8536



811246

811249

Rating (A)	Pack	Cat. Nos.	MRP ₹ / Unit
0.5	1/12/180	811246	581
1	1/12/180	811247	581
2	1/12/180	811249	581
3	1/12/180	811251	581
4	1/12/180	811252	581
5	1/12/180	811253	581
6	1/12/180	811254	490
10	1/12/180	811256	490
16	1/12/180	811258	490
20	1/12/180	811259	490
25	1/12/180	811260	490
32	1/12/180	811261	490
40	1/12/180	811262	834
50	1/12/180	811263	933
63	1/12/180	811264	933

—optipro™—

D Curve Double Pole

HSN Code: 8536



811284

811285

Rating (A)	Pack	Cat. Nos.	MRP ₹ / Unit
0.5	1/6/90	811284	1548
1	1/6/90	811285	1548
2	1/6/90	811287	1548
3	1/6/90	811289	1548
4	1/6/90	811290	1548
5	1/6/90	811291	1548
6	1/6/90	811292	1185
10	1/6/90	811294	1185
16	1/6/90	811296	1185
20	1/6/90	811297	1185
25	1/6/90	811298	1185
32	1/6/90	811299	1185
40	1/6/90	811300	1728
50	1/6/90	811301	1823
63	1/6/90	811302	1823

D Curve Three Pole

HSN Code: 8536



811303

Rating (A)	Pack	Cat. Nos.	MRP ₹ / Unit
0.5	1/4/60	811303	2275
1	1/4/60	811304	2275
2	1/4/60	811306	2275
3	1/4/60	811308	2275
4	1/4/60	811309	2275
5	1/4/60	811310	2275
6	1/4/60	811311	1802
10	1/4/60	811313	1802
16	1/4/60	811315	1802
20	1/4/60	811316	1802
25	1/4/60	811317	1802
32	1/4/60	811318	1802
40	1/4/60	811319	2769
50	1/4/60	811320	2803
63	1/4/60	811321	2803

—optipro™—

D Curve Four Pole

HSN Code: 8536



811341



811342

Rating (A)	Pack	Cat. Nos.	MRP ₹ / Unit
0.5	1/3/45	811341	2780
1	1/3/45	811342	2780
2	1/3/45	811344	2780
3	1/3/45	811346	2780
4	1/3/45	811347	2780
5	1/3/45	811348	2780
6	1/3/45	811349	2377
10	1/3/45	811351	2377
16	1/3/45	811353	2377
20	1/3/45	811354	2377
25	1/3/45	811355	2377
32	1/3/45	811356	2377
40	1/3/45	811357	3456
50	1/3/45	811358	3547
63	1/3/45	811359	3547

—optipro™—

AC Circuit Breaker

- Conforms to IEC 60947-2 • CE Marked • Short-Circuit Breaking Capacity 10kA • 1.5 Module Per Pole
- Large Terminal Size -50sqmm

Single Pole

HSN Code: 8536



811133

Rating (A)	Pack	Cat. Nos.	MRP ₹ / Unit
80	1	811133	2952
100	1	811134	3275
125	1	811135	3646

Double Pole

HSN Code: 8536



811177

Rating (A)	Pack	Cat. Nos.	MRP ₹ / Unit
80	1	811177	6893
100	1	811178	7415
125	1	811179	8127

Three Pole

HSN Code: 8536



811199

Rating (A)	Pack	Cat. Nos.	MRP ₹ / Unit
80	1	811199	10099
100	1	811200	10882
125	1	811201	11823

Four Pole

HSN Code: 8536



811243

Rating (A)	Pack	Cat. Nos.	MRP ₹ / Unit
80	1	811243	13197
100	1	811244	13628
125	1	811245	15494

—optipro™—

DC Circuit Breaker

• Conforms to IEC 60947-2 • CE Marked • Breaking Capacity 6kA • Large Terminal Size -35sqmm and Biconnect
• Upto 250V Supply

Single Pole

HSN Code: 8536



811400

811401

Rating (A)	Pack	Cat. Nos.	MRP ₹ / Unit
0.5	1/12/180	811400	748
1	1/12/180	811401	748
2	1/12/180	811403	748
3	1/12/180	811405	748
4	1/12/180	811406	748
5	1/12/180	811407	748
6	1/12/180	811408	672
10	1/12/180	811410	672
16	1/12/180	811412	672
20	1/12/180	811413	672
25	1/12/180	811414	672
32	1/12/180	811415	672
40	1/12/180	811416	892
50	1/12/180	811417	919
63	1/12/180	811418	919

Double Pole

HSN Code: 8536



811419

811420

Rating (A)	Pack	Cat. Nos.	MRP ₹ / Unit
0.5	1/6/90	811419	1698
1	1/690/	811420	1698
2	1/690/	811422	1698
3	1/690/	811424	1698
4	1/690/	811425	1698
5	1/690/	811426	1698
6	1/690/	811427	1393
10	1/690/	811429	1393
16	1/690/	811431	1393
20	1/690/	811432	1393
25	1/6/90	811433	1393
32	1/690/	811434	1393
40	1/690/	811435	1903
50	1/690/	811436	2044
63	1/690/	811437	2044

—optipro™—

Optipro DC MCB with Extended Link as per RDSO

HSN Code: 8536



811451



811452

Rating (A)	Pack	Cat. Nos.	MRP ₹ / Unit
0.5	1/-/48	811451	795
1	1/-/48	811452	795
1.5	1/-/48	811453	795
1.6	1/-/48	811454	795
2	1/-/48	811455	795
2.5	1/-/48	811456	795
3	1/-/48	811457	795
4	1/-/48	811458	795
5	1/-/48	811459	795
6	1/-/48	811460	747
7.5	1/-/48	811461	747
10	1/-/48	811462	747
15	1/-/48	811463	747
16	1/-/48	811464	747
20	1/-/48	811465	747
25	1/-/48	811466	747
30	1/-/48	811467	747
35	1/-/48	811468	987
40	1/-/48	811469	987
50	1/-/48	811470	987
60	1/-/48	811471	987

—optipro™—

Optipro Isolator

• Conforms to IEC 60947-3 • CE Marked • Large Terminal Size -35sqmm and Biconnect

Double Pole

HSN Code: 8536



811550

Rating (A)	Pack	Cat. Nos.	MRP ₹ / Unit
40	1/6/90	811550	715
63	1/6/90	811551	883
80	1/6/90	811552	1139
100	1/6/90	811553	1139
125	1/6/90	811554	1228

Three Pole

HSN Code: 8536



811555

Rating (A)	Pack	Cat. Nos.	MRP ₹ / Unit
40	1/4/60	811555	1336
63	1/4/60	811556	1530
80	1/4/60	811557	1723
100	1/4/60	811558	1723
125	1/4/60	811559	1891

Four Pole

HSN Code: 8536



811560

Rating (A)	Pack	Cat. Nos.	MRP ₹ / Unit
40	40	811560	1596
63	1/3/45	811561	1723
80	1/3/45	811562	2139
100	1/3/45	811563	2139
125	1/3/45	811564	2314

—optipro™—

Residual Current Circuit Breaker-RCCB

• Conforms to IS/IEC 12640-1 • Short-Circuit Breaking Capacity 10kA • Biconnect Terminals • Ergonomic Test button

Double Pole

HSN Code: 8536

	Rating (A)	Sensitivity(mA)	Pack	Cat. Nos.	MRP ₹ / Unit
		30	1/6/90	811700	3965
	25	100	1/6/90	811706	4000
		300	1/6/90	811712	4000
811700	40	30	1/6/90	811701	4072
		100	1/6/90	811707	4144
		300	1/6/90	811713	4144
	63	30	1/6/90	811702	5445
		100	1/6/90	811708	5540
		300	1/6/90	811714	5540

Four Pole

HSN Code: 8536

	Rating (A)	Sensitivity(mA)	Pack	Cat. Nos.	MRP ₹ / Unit
		30	1/3/45	811718	5084
	25	100	1/3/45	811724	5151
		300	1/3/45	811730	5151
	40	30	1/3/45	811719	5217
		100	1/3/45	811725	5262
		300	1/3/45	811731	5262
811718	63	30	1/3/45	811720	5643
		100	1/3/45	811726	5643
		300	1/3/45	811732	5643

—optipro™—

RCD Add on Block

- Conforms to IEC 60947-2 • Large Terminal Size -35sqmm • Short-Circuit Breaking Capacity 10kA
- Dual Position DIN Clip • Flexibility to use MCB of any Tripping Curve.

Double Pole

HSN Code: 8536



Rating (A)	Sensitivity(mA)	Pack	Cat. Nos.	MRP ₹ / Unit
6A - 32A	30	1/ - /32	811666	3412
	100	1/ - /32	811668	4077
	300	1/ - /32	811670	4388
40A & 63A	30	1/ - /32	811667	4388
	100	1/ - /32	811669	4821
	300	1/ - /32	811671	5262

Four Pole

HSN Code: 8536





Rating (A)	Sensitivity(mA)	Pack	Cat. Nos.	MRP ₹ / Unit
6A - 32A	30	1/ - /16	811672	4218
	100	1/ - /16	811674	4710
	300	1/ - /16	811676	4913
40A & 63A	30	1/ - /16	811673	5054
	100	1/ - /16	811675	5495
	300	1/ - /16	811677	5927

—optipro™—

Accessories

• Conforms to IEC 60947 - 5 - 1 • Retro Fit Type Clip On Accessory • CE Marked • Upto Three Number of Accessory on a Modular Device • Common Accessories for Entire Range • Easy to Install

HSN Code: 8538

	Item Description	Pack	Cat. Nos.	MRP ₹ / Unit
 <p>811580</p>	Auxiliary Changeover Switch 1NC	1	811580	538
	Fault Signalling Contact 1NC	1	811581	1278
	Shunt Trip 12V to 48V AC/DC	1	811582	2201
 <p>811581</p>	Shunt Trip 110V to 415V AC	1	811583	2201
	Undervoltage 24V & 48V AC/DC	1	811584	1921
	Undervoltage 240V AC	1	811585	1921

Engineered to perfection with a wide range and unmatched quality

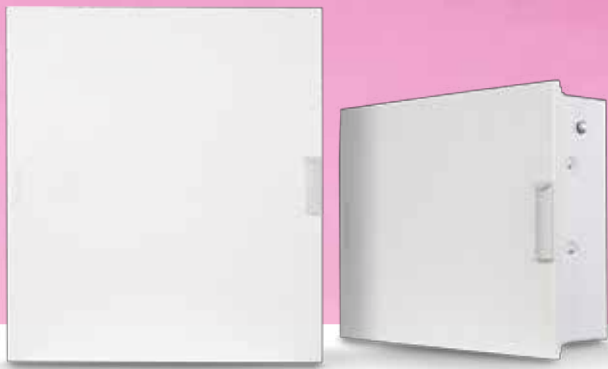

Scan to know more about the product

Optipro DBs are engineered for safe, organized & efficient power distribution offering a sturdy build, clean internal layout and flexible configurations suited for wide range of different applications.

Features

- IP protection upto IP54 making it suitable for varied applications
- Sleek finish that enhances any modern interior
- Available in SPN, TPN, VTPN, Flexi, and specialized phase selector DBs

Benefits

- Smooth corners safe, sleek, effortless handling
- Door earthing and shrouded busbars ensure maximum user safety
- Easy installation with cement spill protectors and independent shield

—optipro™—

Optipro Distribution Boards (DBS)

SPN DB-Single Door

• IP : 30 Protection • Isolated Neutral Bar • Cement Spill Protector • Door Earthing • Mechanical Impact Strength IK 08

HSN Code: 8537



811800

Ways	Modules	Cat. Nos.	MRP ₹ / Unit
4	4	811800	1693
6	6	811801	1772
8	8	811802	2075
12	12	811803	2430
16	16	811804	3035

SPN DB-Double Door

• IP : 43 Protection • Door Earthing • Isolated Neutral Bar • Mechanical Impact Strength IK 09

HSN Code: 8537



811805

Ways	Modules	Cat. Nos.	MRP ₹ / Unit
4	4	811805	2529
6	6	811806	2732
8	8	811807	2832
10	10	811812	3239
12	12	811808	3415
14	14	811810	3743
16	16	811809	4147
18	18	811811	4554

—optipro™—

SPN DB-Double Door

• IP : 54 Protection • Door Earthing • Isolated Neutral Bar • Mechanical Impact Strength IK 09

HSN Code: 8537



811824

Ways	Modules	Cat. Nos.	MRP ₹ / Unit
4	4	811824	3932
6	6	811825	4803
8	8	811826	5132
12	12	811828	6638
16	16	811829	8195

SPN DB-Acrylic Door

• IP : 43 Protection • Door Earthing • Isolated Neutral Bar • Mechanical Impact Strength IK 09

HSN Code: 8537



811816

Ways	Modules	Cat. Nos.	MRP ₹ / Unit
4	4	811816	2680
6	6	811817	3191
8	8	811818	3370
12	12	811819	4138
16	16	811820	5108

TPN DB-Single Door

• IP : 30 Protection • Door Earthing • Isolated Neutral Bar • Mechanical Impact Strength IK 08

HSN Code: 8537



811832

Ways	Modules	Cat. Nos.	MRP ₹ / Unit
4 Way compact	4+12	811832	4222
4 Way	8+12	811833	4454
6 Way compact	4+18	811834	5160
6 Way	8+18	811835	5512
8 Way	8+24	811836	6527
12 Way	8+36	811837	9384
16 Way	8+48	811838	11560

—optipro™—

TPN DB-Double Door

• IP : 43 Protection • Door Earthing • Isolated Neutral Bar • Mechanical Impact Strength IK 09

HSN Code: 8537



811840

Ways	Modules	Cat. Nos.	MRP ₹ / Unit
4 Way compact	4+12	811840	5286
4 Way	8+12	811841	5542
6 Way compact	4+18	811842	6511
6 Way	8+18	811843	6920
8 Way	8+24	811844	8299
12 Way	8+36	811845	12435
16 Way	8+48	811846	15449

TPN DB-Double Door

• IP : 54 Protection • Door Earthing • Isolated Neutral Bar • Mechanical Impact Strength IK 09

HSN Code: 8537



811856

Ways	Modules	Cat. Nos.	MRP ₹ / Unit
4 Way compact	4+12	811856	9856
4 Way	8+12	811857	11135
6 Way compact	4+18	811858	12767
6 Way	8+18	811859	13917
8 Way	8+24	811860	17287
12 Way	8+36	811861	24564
16 Way	8+48	811862	29364

—optipro™—

TPN DB-Acrylic Door

• Door Earthing • IP : 43 Protection • Isolated Neutral Bar • Cement Spill Protector

HSN Code: 8537



811848

Ways	Modules	Cat. Nos.	MRP ₹ / Unit
4 Way compact	4+12	811848	6615
4 Way	8+12	811849	7200
6 Way compact	4+18	811850	8376
6 Way	8+18	811851	8988
8 Way	8+24	811852	11182
12 Way	8+36	811853	15831
16 Way	8+48	811854	19124

VTPN MCB DB-Single Door

• IP : 30 Protection • Door Earthing • Isolated Neutral Bar • Mechanical Impact Strength IK 08

HSN Code: 8537



811864

Ways	Modules	Cat. Nos.	MRP ₹ / Unit
4 Way	8+12	811864	12064
6 Way	8+18	811865	13255
8 Way	8+24	811866	14747
12 Way	8+36	811867	19829

VTPN MCB DB-Double Door

• IP : 43 Protection • Door Earthing • Isolated Neutral Bar • Mechanical Impact Strength IK 09

HSN Code: 8537



811870

Ways	Modules	Cat. Nos.	MRP ₹ / Unit
4 Way	8+12	811870	13560
6 Way	8+18	811871	16114
8 Way	8+24	811872	17682
12 Way	8+36	811873	22638

—optipro™—

VTPN MCB DB-Double Door

• IP : 54 Protection • Door Earthing • Isolated Neutral Bar • Mechanical Impact Strength IK 09

HSN Code: 8537



811882

Ways	Modules	Cat. Nos.	MRP ₹ / Unit
4 Way	8+12	811882	20837
6 Way	8+18	811883	26080
8 Way	8+24	811884	31719
12 Way	8+36	811885	39889

VTPN MCCB 125A DB-Double Door

• IP : 43 Protection • Door Earthing • Isolated Neutral Bar • Mechanical Impact Strength IK 09

HSN Code: 8537



811888

Ways	Modules	Cat. Nos.	MRP ₹ / Unit
4 Way	Optium F1+12	811888	15707
6 Way	Optium F1+18	811889	17761
8 Way	Optium F1+24	811890	19391
12 Way	Optium F1+36	811891	26408

VTPN MCCB 125A DB-Double Door

• IP : 54 Protection • Door Earthing • Isolated Neutral Bar • Mechanical Impact Strength IK 09

HSN Code: 8537



812040

Ways	Modules	Cat. Nos.	MRP ₹ / Unit
4 Way	Optium F1+12	812040	26080
6 Way	Optium F1+18	812041	29504
8 Way	Optium F1+24	812042	31563
12 Way	Optium F1+36	812043	42558

—optipro™—

VTPN MCCB 250A DB-Double Door

• IP : 43 Protection • Door Earthing • Isolated Neutral Bar • Mechanical Impact Strength IK 09

HSN Code: 8537



Ways	Modules	Cat. Nos.	MRP ₹ / Unit
4 Way	Optium F2+12	811893	22024
6 Way	Optium F2+18	811894	23402
8 Way	Optium F2+24	811895	25882
12 Way	Optium F2+36	811896	32921

VTPN MCCB 250A DB-Double Door

• IP : 54 Protection • Door Earthing • Suitable for MCCB's upto 250A as I/C (Frame 2) • Isolated Neutral Bar
• Mechanical Impact Strength IK 09 • Cement Spill Protector

HSN Code: 8537



Ways	Modules	Cat. Nos.	MRP ₹ / Unit
4 Way	Optium F2+12	812045	42309
6 Way	Optium F2+18	812046	45139
8 Way	Optium F2+24	812047	49903
12 Way	Optium F2+36	812048	56059

Flexi DB-Double Door

• IP : 43 Protection • Door Earthing • Isolated Neutral Bar • Mechanical Impact Strength IK 09

HSN Code: 8537



Ways	Modules	Cat. Nos.	MRP ₹ / Unit
14 X 2 Row	28	811912	7090
14 X 3 Row	42	811913	8443
14 X 4 Row	56	811915	9372

Flexi DB-Double Door

• IP : 54 Protection • Door Earthing • Cement Spill Protector • Isolated Neutral Bar • Mechanical Impact Strength IK 09

HSN Code: 8537



Ways	Modules	Cat. Nos.	MRP ₹ / Unit
14 X 2 Row	28	812030	11535
14 X 3 Row	42	812031	14064
14 X 4 Row	56	812033	15508

—optipro™—

7 SEGMENT DB-Double Door

• IP : 43 Protection • Door Earthing • Cement Spill Protector • Isolated Neutral Bar • Mechanical Impact Strength IK 09

HSN Code: 8537



811925

Ways	Modules	Cat. Nos.	MRP ₹ / Unit
4 Way	8+12+12	811925	13879
6 Way	8+12+18	811926	15558
8 Way	8+12+24	811927	17538
12 Way	8+12+36	811928	21696
16 Way	8+12+48	811929	22299

Phase Selector DB 40A Double Door

• IP : 43 Protection • Door Earthing • Compartmentalized Solution • Mechanical Impact Strength IK 09

• 40 A Prefitted Selector Switch

HSN Code: 8537



811940

Ways	Modules	Cat. Nos.	MRP ₹ / Unit
4 Way	8+12	811940	16281
6 Way	8+18	811941	16997
8 Way	8+24	811942	18437
12 Way	8+36	811943	20446

Phase Selector DB 63A Double Door

• IP : 43 Protection • Door Earthing • 63 A prefitted selector switch • Isolated Neutral Bar

• Mechanical Impact Strength IK 09

HSN Code: 8537



811950

Ways	Modules	Cat. Nos.	MRP ₹ / Unit
4 Way	8+12	811950	18785
6 Way	8+18	811951	19601
8 Way	8+24	811952	20672
12 Way	8+36	811953	23251

—optipro™—

Metal Clad P&S

• IP : 30 Protection • Without MCBs • Mechanical Impact Strength IK 08

HSN Code: 8537



Ways	Modules	Cat. Nos.	MRP ₹ / Unit
20A 2P+E	1 Mod	811955	1871
20A 2P+E	2 Mod	811956	1871
20A 3P+E	3 Mod	811957	4068
32A 3P+E	3 Mod	811958	4836

TV/TEL DB

• IP : 43 Protection • Door Earthing • Factory Fitted KRONE type TV & TEL Socket • Isolated & Shrouded Neutral Bar
• Mechanical Impact Strength IK 09

HSN Code: 8537



Ways	Modules	Cat. Nos.	MRP ₹ / Unit
8 Way SPN	8	811963	5483
12 Way SPN	12	811964	6177
16 Way SPN	16	811965	7044
4 Way TPN	8+12	811967	9133
6 Way TPN	8+18	811983	10274
8 Way TPN	8+24	811968	11512

PPI DB-Double Door

• IP : 43 Protection • Door Earthing • Cement Spill Protector • Isolated Neutral Bar for Individual Phase
• Mechanical Impact Strength IK 09

HSN Code: 8537



Ways	Modules	Cat. Nos.	MRP ₹ / Unit
Hori 4+2 Way	8+6+12	811971	9379
Hori 6+2 Way	8+6+18	811972	11512
Hori 8+2 Way	8+6+24	811973	13623
Hori 12+2 Way	8+6+36	811998	16781
Tier 6+2 Way	8+6+18	811974	11142
Tier 8+2 Way	8+6+24	811975	13897
Tier 12+2 Way	8+6+36	811976	16552

—optipro™—

PPI DB-Double Door

• IP :54 Protection • Isolated Neutral Bar • Cement Spill Protector • Door Earthing • Mechanical Impact Strength IK 09

HSN Code: 8537



812034

Ways	Modules	Cat. Nos.	MRP ₹ / Unit
Hori 4+2 Way	8+6+12	812034	18238
Hori 6+2 Way	8+6+18	812035	22360
Hori 8+2 Way	8+6+24	812036	25346
Tier 6+2 Way	8+6+18	812037	18491
Tier 8+2 Way	8+6+24	812038	23095
Tier 12+2 Way	8+6+36	812039	26865

Plastic P&S

• IP : 30 Protection • Without MCBs

HSN Code: 8537



811959

Ways	Modules	Cat. Nos.	MRP ₹ / Unit
16A 2P+E	2 Mod	811959	3697
32A 2P+E	2 Mod	811960	3799
32A 3P+N+E	4 Mod	811961	6079
63A 3P+N+E	4 Mod	811962	16030

Enclosures

HSN Code: 8537



811977

Ways	Modules	Cat. Nos.	MRP ₹ / Unit
1/2 Mod plastic	2	811977	249
3/4 Mod plastic	4	811978	420
1 Mod metal	1	811979	619
2 Mod metal	2	811980	619
3 Mod metal	3	811981	820
4 Mod metal	4	811982	820

—optipro™—

Cable End Box

• IP : 43 Protection • Mechanical Impact Strength IK08

HSN Code: 8537



812000



812001

Description	Cat. Nos.	MRP ₹ / Unit
CEB SPN DD 4W DB	812000	1128
CEB SPN DD 6W DB	812001	1207
CEB SPN DD 8W DB	812002	1286
CEB SPN DD 10W DB	812003	1437
CEB SPN DD 12W DB	812004	1514
CEB SPN DD 14W DB	812005	1618
CEB SPN DD 16W DB	812006	1822
CEB SPN DD 18W DB	812007	1953
CEB TPN DD 4W 4 POLE I/C DB	812008	1385
CEB TPN DD 4W 8 POLE I/C DB	812009	1668
CEB TPN DD 6W 8P I/C DB or PPI HORI. DD DB 4+2W	812010	1975
CEB TPN DD 8W DB or PPI HORI. DD DB 6+2W	812011	2436
CEB TPN DD 10W DB or PPI HORI. DD DB 8+2W	812012	2848
CEB TPN DD 12W DB	812013	3336
CEB TPN DD 16W DB	812014	3413
CEB VTPN MCB I/C DB or VTPN MCCB I/C DD DB	812015	2667
CEB FLEXY DD 14 MOD. PER ROW DB	812017	2411
CEB PPI TIER 6+2W	812018	2387
CEB PPI TIER 8+2W	812019	2823
CEB PPI TIER 12+2W	812020	2976

—optipro™—

MCCB Enclosure

• Solid Neutral Link for 3 Pole MCCBs



811984

Description	Pack	Cat. Nos.	MRP ₹ / Unit
Optipro Enclosure for Frame-1 Optimum 3 Pole MCCB	1	811984	2335
Optipro Enclosure for Frame-1 Optimum 4 Pole MCCB	1	811985	2335
Optipro Enclosure for Frame-2 Optimum 3 Pole MCCB	1	811986	3517
Optipro Enclosure for Frame-2 Optimum 4 Pole MCCB	1	811987	3517
Optipro Enclosure for Frame-3 Optimum 3 Pole MCCB	1	811988	3517
Optipro Enclosure for Frame-3 Optimum 4 Pole MCCB	1	811989	3517
Optipro Enclosure for Frame-4 Optimum 3 Pole MCCB	1	811990	8753
Optipro Enclosure for Frame-4 Optimum 4 Pole MCCB	1	811991	8753

Busbar Chamber

TPN BBC (Cu-Busbar)

Solution for Safe Power Distribution • Step Type Design • Available in both SPN & TPN Configuration **HSN Code: 8536**



CPPI1015

Description	Ingress Protection*	Cat. Nos.	MRP ₹ / Unit
Spl. 32A TPN BBC (Cu) with 4 o/g ways	IP42	CPPI1015	10130
Spl. 63A TPN BBC (Cu) with 4 o/g ways	IP42	CPPI1016	11290
Spl. 100A TPN BBC (Cu) with 4 o/g ways	IP42	CPPI1017	12510
Spl. 200A TPN BBC (Cu) with 4 o/g ways	IP42	CPPI1018	15480
Spl. 250A TPN BBC (Cu) with 4 o/g ways	IP42	CPPI1019	22030
Spl. 320A TPN BBC (Cu) with 4 o/g ways	IP42	CPPI1020	26760
Spl. 400A TPN BBC (Cu) with 4 o/g ways	IP42	CPPI1021	29740
Spl. 630A TPN BBC (Cu) with 4 o/g ways	IP42	CPPI1022	47570

—optipro™—

Busbar Chamber

• Solution for Safe Power Distribution • Step Type Design • Available in both SPN & TPN Configuration

HSN Code: 8536



CPPI1025

*Also Available in IP54 Design

Item Description	Ingress Protection*	Cat. Nos.	MRP ₹ / Unit
Spl. 32A TPN BBC (Al.) with 4 o/g ways	IP42	CPPI1023	9520
Spl. 63A TPN BBC (Al.) with 4 o/g ways	IP42	CPPI1024	10130
Spl. 100A TPN BBC (Al.) with 4 o/g ways	IP42	CPPI1025	10680
Spl. 200A TPN BBC (Al.) with 4 o/g ways	IP42	CPPI1026	11290
Spl. 250A TPN BBC (Al.) with 4 o/g ways	IP42	CPPI1027	13650
Spl. 320A TPN BBC (Al.) with 4 o/g ways	IP42	CPPI1028	14870
Spl. 400A TPN BBC (Al.) with 4 o/g ways	IP42	CPPI1029	15480
Spl. 630A TPN BBC (Al.) with 4 o/g ways	IP42	CPPI1008	26600

Metal Clad Plug & Socket AC Plug

HSN Code: 8536



810385

Rating	Pack	Cat. Nos.	MRP ₹ / Unit
10A 2P+E, 230V AC	1/10/100	810385	212
20A 2P+E, 230V AC	1/10/100	810386	227
20A 3P+E, 230V / 415V AC	1/10/100	810387	309
32A 3P+E, 230V / 415V AC	1/10/100	810388	557

—optipro™—

AC Socket

HSN Code: 8536

	Rating	Pack	Cat. Nos.	MRP ₹ / Unit
 <p>810389</p>	10A 2P+E, 230V AC	1/10/100	810389	212
	20A 2P+E, 230V AC	1/10/100	810390	244
	20A 3P+E, 230V / 415V AC	1/10/100	810391	322
	32A 3P+E, 230V / 415V AC	1/10/100	810392	557

Time Switches

Analog Time Switches (with Battery Back Up)

HSN Code: 9107

	Model Name	Description	Cat. Nos.	MRP ₹ / Unit
 <p>TA916422</p>	1mod DIN Daily	1P Module, 24 hours program, Programmable every 15 min., backup of 100 hours, current capacity 16A, with 1 changeover (1 CO)	TA916422	5038
	3mod DIN Daily	"3P Module, 24 hours program, Programmable every 15 min., backup of 100 hrs., current capacity 16A, with 1 changeover (1 CO)"	TA926453	5489

Digital Time Switches

HSN Code: 9107

	Model Name	Description	Cat. Nos.	MRP ₹ / Unit
 <p>TDA43110</p>	DIN Type Daily / Weekly with 1 CO	Programmable every 1 min., with backup of 6 years, 28 memory locations, current capacity 16A, weekly program, with 1 changeover (1 CO), Total 28 programs	TDA43110	6670
	DIN Type Daily / Weekly with 2 CO	Programmable every 1 min., with backup of 6 years, 28 memory locations, current capacity 16A, weekly program, with 2 changeover (2 CO), Total 14 programs per channel	TDA43111	10010
	DIN Type Astronomical with 1 CO	Astronomical Programmable every 1 min., backup of 6 years, 28 memory locations, current capacity 16A, with 1 changeover (1 CO), Total 28 programs	TDA45163	13886
	DIN Type Astronomical with 2 CO	Astronomical Programmable every 1 min., backup of 6 years, 28 memory locations, current capacity 16A, with 2 changeover (2 CO), Total 14 programs	TDA45164	17350

—optipro™—

Light Sensitive Switches

HSN Code: 9107



TSA58107

Model Name	Description	Cat. Nos.	MRP ₹ / Unit
1mod DIN Light Sensitive	"Light sensitive switch with outer sensor, sensitive distance 50m, current capacity 16A & control from 1 lux to 100K lux. current capacity 16A & control from 1 lux to 100K lux."	TSA58107	11570

Timelite Distribution Boards

HSN Code: 8537



TL016ASO

Description	Cat. Nos.	MRP ₹ / Unit
Timelite-16A 3Pole/230V-Analog Time switch	TL016ABO	32542
Timelite-32A 3Pole/230V-Analog Time switch	TL032ABO	35201
Timelite-32A 3Pole/230V-Digital Time Switch	TL032DBO	38419
Timelite-32A 3Pole/230V-Astronomical Time Switch	TL032ASO	44832
Timelite-40A 3Pole/230V-Analog Time Switch	TL040ABO	37920
Timelite -40A 3Pole/230V-Digital Time Switch	TL040DBO	41071
Timelite-40A 3Pole/230V-Astronomical Time Switch	TL040ASO	47491
Timelite-65A 3Pole/230V-Analog Time Switch	TL065ABO	48542
Timelite-65A 3Pole/230V-Digital Time Switch	TL065DBO	51749
Timelite-65A 3Pole/230V-Astronomical Time Switch	TL065ASO	58138
Timelite-110A 3Pole/230V-Analog Time Switch	TL110ABO	81264
Timelite-110A 3Pole/230V-Digital Time Switch	TL110DBO	83741
Timelite-110A 3Pole/230V-Astronomical Time Switch	TL110ASO	90994

The analog time switch which will be used in Timelite DBs is TA926453
 The digital time switch which will be used in Timelite DBs is TDA43110
 The astronomical time switch which will be used in Timelite DBs is TDA45163
 SM based SMART Timelite DB's are also available on request.

—optipro™—

Automatic Changeover with Current Limiter

• As per IEC60947-6-1 • Intelligent Micro Controller Based Design • RoHS Compliant

HSN Code: 8536



810400



810401

Rating (A)	Pack	Cat. Nos.	MRP ₹ / Unit
SPN 30A Mains 1.5A DG ACCL	1/3/45	810409	2608
SPN 30A Mains 2.5A DG ACCL	1/3/45	810410	2608
SPN 30A Mains 3A DG ACCL	1/3/45	810400	2608
SPN 30A Mains 4A DG ACCL	1/3/45	810401	2608
SPN 30A Mains 5A DG ACCL	1/3/45	810402	2608
SPN 30A Mains 6A DG ACCL	1/3/45	810403	2608
SPN 30A Mains 9A DG ACCL	1/3/45	810404	2608
SPN 30A Mains 12A DG ACCL	1/3/45	810405	2608
SPN 30A Mains 15A DG ACCL	1/3/45	810406	2608
SPN 30A Mains 20A DG ACCL	1/3/45	810407	2608
SPN 30A Mains 30A DG ACCL	1/3/45	810408	2608

Ensuring reliable performance at high ambient & humid environments



Scan to know more about the product

Optium MCCBs represent advanced MCCB technology, delivering intelligent protection, robust performance, and a wide range of options for complex electrical infrastructure, ensuring adaptability, safety, and durability.

Features

- Delivers breaking capacities ranging from 10kA – 50kA
- Wide range from 16A – 250A in compact frames and up to 1250A in larger frames
- Multiple series of ranges with fine-tunable protection settings

Benefits



- Offers reliable protection against overloads, short circuits, and ground faults across a wide performance range
- Flexibility in system design using adjustable settings and multiple frames
- Improved uptime and easier maintenance through long mechanical/electrical endurance

optium™
ALL THAT YOU NEED
MCCB



Optium 1.0 (Fixed TM MCCB Range)

• Ics =50% Icu as per IEC 60947-II • Suitable For Isolation Fixed Overload & Fixed Short Circuit Setting

HSN Code: 8536

		Frame	Breaking Capacity	Rating	3P	MRP ₹ / Unit	4P	MRP ₹ / Unit
		F1	10kA	16	830701	3470	830710	4210
		F1	10kA	25	830702	3470	830711	4210
		F1	10kA	32	830703	3470	830712	4210
		F1	10kA	40	830704	3470	830713	4210
		F1	10kA	50	830705	3470	830714	4210
		F1	10kA	63	830706	3470	830715	4210
		F1	10kA	80	830707	3910	830716	5000
		F1	10kA	100	830708	3920	830717	5020
		F1	10kA	125	830709	5600	830718	7230

HSN Code: 8536

		Frame	Breaking Capacity	Rating	3P	MRP ₹ / Unit	4P	MRP ₹ / Unit
		F1	16kA	16	830001	5770	830015	7050
		F1	16kA	25	830002	5770	830016	7050
		F1	16kA	32	830003	5770	830017	7050
		F1	16kA	40	830004	5770	830018	7050
		F1	16kA	50	830005	5770	830019	7050
		F1	16kA	63	830006	5770	830020	7050
		F1	16kA	80	830007	6060	830021	7800
		F1	16kA	100	830008	6060	830022	7800
		F1	16kA	125	830009	8390	830023	11030

optium™
ALL THAT YOU NEED
MCCB





Optium 1.0 (Fixed TM MCCB Range)

HSN Code: 8536

		Frame	Breaking Capacity	Rating	3P	MRP ₹ / Unit	4P	MRP ₹ / Unit
		F1	25kA	16	830031	6950	830045	8300
830031	830032	F1	25kA	25	830032	6950	830046	8300
		F1	25kA	32	830033	6950	830047	8300
		F1	25kA	40	830034	6950	830048	8300
		F1	25kA	50	830035	6950	830049	8300
		F1	25kA	63	830036	6950	830050	8300
830034	830035	F1	25kA	80	830037	7150	830051	8710
		F1	25kA	100	830038	7150	830052	8710
		F1	25kA	125	830039	8610	830053	11460

Optium 1.0 (Fixed TM MCCB Range)





HSN Code: 8536

		Frame	Breaking Capacity	Rating	3P	MRP ₹ / Unit	4P	MRP ₹ / Unit
		F1	36kA	16	830061	9190	830075	10510
830061	830062	F1	36kA	25	830062	9190	830076	10510
		F1	36kA	32	830063	9190	830077	10510
		F1	36kA	40	830064	9190	830078	10510
		F1	36kA	50	830065	9190	830079	10510
		F1	36kA	63	830066	9190	830080	10510
830063	830064	F1	36kA	80	830067	9330	830081	11080
		F1	36kA	100	830068	9330	830082	11080
		F1	36kA	125	830069	12860	830083	13370





optium™
ALL THAT YOU NEED
MCCB

Optium 1.0 (Fixed TM MCCB Range)

HSN Code: 8536

		Frame	Breaking Capacity	Rating	3P	MRP ₹ / Unit	4P	MRP ₹ / Unit
		F3	50kA	16	830125	10630	830145	12930
		F3	50kA	25	830126	10630	830146	12930
		F3	50kA	32	830127	10630	830147	12930
		F3	50kA	40	830128	10630	830148	12930
		F3	50kA	50	830129	10630	830149	12930
		F3	50kA	63	830130	10630	830150	12930
		F3	50kA	80	830131	11170	830151	13320
		F3	50kA	100	830132	11170	830152	13320
		F3	50kA	125	830133	13030	830153	16520



HSN Code: 8536

		Frame	Breaking Capacity	Rating	3P	MRP ₹ / Unit	4P	MRP ₹ / Unit
		F2	16kA	160	830090	8970	830095	13010
		F2	16kA	200	830091	11610	830096	15110
		F2	16kA	250	830092	12810	830097	15960
		F2	25kA	160	830100	10610	830105	13030
		F2	25kA	200	830101	14330	830106	17340
		F2	25kA	250	830102	18490	830107	21740
		F2	36kA	160	830110	13050	830115	16000
		F2	36kA	200	830111	16720	830116	21120
		F2	36kA	250	830112	21820	830117	28700



optium™
ALL THAT YOU NEED
MCCB

Optium 1.0 (Fixed TM MCCB Range)

HSN Code: 8536



		Frame	Breaking Capacity	Rating	3P	MRP ₹ / Unit	4P	MRP ₹ / Unit
 830134	 830135	F3	50kA	160	830134	14580	830154	20020
		F3	50kA	200	830135	17550	830155	24630
		F3	50kA	250	830136	22560	830156	29980

HSN Code: 8536

		Frame	Breaking Capacity	Rating	3P	MRP ₹ / Unit	4P	MRP ₹ / Unit
 830165	 830166	F4	36kA	315	830165	29470	830175	33620
		F4	36kA	400	830166	31140	830176	35520
		F4	36kA	500	830167	34850	830177	40330
		F4	36kA	630	830168	36940	830178	42440

Optium 1.0 (Fixed TM MCCB Range)

HSN Code: 8536

		Frame	Breaking Capacity	Rating	3P	MRP ₹ / Unit	4P	MRP ₹ / Unit
 830185	 830186	F4	50kA	315	830185	30330	830195	35960
		F4	50kA	400	830186	33100	830196	38840
		F4	50kA	500	830187	35990	830197	41750
		F4	50kA	630	830188	38150	830198	43260

Optium 1.0 (Fixed TM MCCB Range)

HSN Code: 8536









		Frame	Breaking Capacity	Rating	3P	MRP ₹ / Unit	4P	MRP ₹ / Unit
 830200		F5	50kA	800	830200	49710	830201	64210

optium™
ALL THAT YOU NEED
MCCB

Optium 1.1 (Fixed TM MCCB Range)

• Ics = 100% Icu as per IEC 60947-II • Class II Front Face • Suitable for Isolation • Fixed Overload & Fixed Short Circuit Setting

HSN Code: 8536

	Frame	Breaking Capacity	Rating	3P	MRP ₹ / Unit	4P	MRP ₹ / Unit
	F1	16kA	32	840003	6010	840017	7880
	F1	16kA	40	840004	6010	840018	7880
	F1	16kA	63	840006	6010	840020	7880
	F1	16kA	80	840007	6240	840021	8430
	F1	16kA	100	840008	6240	840022	8430
	F1	16kA	125	840009	8750	840023	11760
	F1	25kA	32	840033	7290	840047	9230
	F1	25kA	40	840034	7290	840048	9230
	F1	25kA	63	840036	7290	840050	9230
	F1	25kA	80	840037	7720	840051	9410
	F1	25kA	100	840038	7720	840052	9410
	F1	25kA	125	840039	8930	840053	13200
	F2	16kA	160	840090	9250	840095	13800
	F2	16kA	200	840091	11620	840096	15420
	F2	16kA	250	840092	13240	840097	17680
	F2	25kA	160	840100	10770	840105	14240
	F2	25kA	200	840101	15120	840106	18160
	F2	25kA	250	840102	19540	840107	24420





optium™
ALL THAT YOU NEED
MCCB

Optium 2.0 (Adjustable Thermal Setting MCCB)





• Conforms to IEC 60947-II • Ics = 100% Icu • Class II Front Face • Suitable for Isolation • Adjustable Overload

Setting Ir = (0.8 to 1.0) x In • Short Circuit Setting Fixed

HSN Code: 8536

	Frame	Breaking Capacity	Rating	3P	MRP ₹ / Unit	4P	MRP ₹ / Unit
 830222	F1	16kA	25	830222	6110	830236	8160
 830223	F1	16kA	32	830223	6110	830237	8160
	F1	16kA	40	830224	6110	830238	8160
 830224	F1	16kA	50	830225	6110	830239	8160
 830225	F1	16kA	63	830226	6110	830240	8160
	F1	16kA	80	830227	6620	830241	8770
	F1	16kA	100	830228	6620	830242	8770
	F1	16kA	125	830229	9050	830243	12230

HSN Code: 8536

	Frame	Breaking Capacity	Rating	3P	MRP ₹ / Unit	4P	MRP ₹ / Unit
 830252	F1	25kA	25	830252	7660	830266	9650
 830253	F1	25kA	32	830253	7660	830267	9650
	F1	25kA	40	830254	7660	830268	9650
	F1	25kA	50	830255	7660	830269	9650
	F1	25kA	63	830256	7660	830270	9650
 830254	F1	25kA	80	830257	8040	830271	10120
 830255	F1	25kA	100	830258	8040	830272	10120
	F1	25kA	125	830259	9310	830273	13850

optium™
ALL THAT YOU NEED
MCCB

Optium 2.0 (Adjustable Thermal Setting MCCB)

HSN Code: 8536



830280

830281

Frame	Breaking Capacity	Rating	3P	MRP ₹ / Unit	4P	MRP ₹ / Unit
F2	16kA	160	830280	9710	830285	14290
F2	16kA	200	830281	12100	830286	16010
F2	16kA	250	830282	14000	830287	18920
F2	25kA	160	830290	12290	830295	16120
F2	25kA	200	830291	15720	830296	20290
F2	25kA	250	830292	21020	830297	26290

Optium 2.0 (Adjustable TM MCCB Range)

• Ics =100% Icu as per IEC 60947-II • Class II Front Face • Suitable for Isolation • Adjustable Overload Setting

$I_r = (0.8 \text{ to } 1.0) \times I_n$ • Adjustable Short Circuit Setting $I_{sd} = (5 - 10) \times I_n$

HSN Code: 8536



830305

830306



830307

830308

Frame	Breaking Capacity	Rating	3P	MRP ₹ / Unit	4P	MRP ₹ / Unit
F3	36kA	16	830305	9910	830325	13700
F3	36kA	25	830306	9910	830326	13700
F3	36kA	32	830307	9910	830327	13700
F3	36kA	40	830308	9910	830328	13700
F3	36kA	50	830309	9910	830329	13700
F3	36kA	63	830310	9910	830330	13700
F3	36kA	80	830311	10110	830331	14100
F3	36kA	100	830312	10110	830332	14100
F3	36kA	125	830313	13110	830333	15800

optium™
ALL THAT YOU NEED
MCCB

Optium 2.0 (Adjustable Thermal Setting MCCB)

HSN Code: 8536



830345



830346

Frame	Breaking Capacity	Rating	3P	MRP ₹ / Unit	4P	MRP ₹ / Unit
F3	50kA	16	830345	13350	830365	15950
F3	50kA	25	830346	13350	830366	15950
F3	50kA	32	830347	13350	830367	15950
F3	50kA	40	830348	13350	830368	15950
F3	50kA	50	830349	13350	830369	15950
F3	50kA	63	830350	13350	830370	15950
F3	50kA	80	830351	13620	830371	16110
F3	50kA	100	830352	13620	830372	16110
F3	50kA	125	830353	14980	830373	19230

HSN Code: 8536



830314

Frame	Breaking Capacity	Rating	3P	MRP ₹ / Unit	4P	MRP ₹ / Unit
F3	36kA	160	830314	16560	830334	19710
F3	36kA	200	830315	18570	830335	25710
F3	36kA	250	830316	24400	830336	33670

HSN Code: 8536



830354

Frame	Breaking Capacity	Rating	3P	MRP ₹ / Unit	4P	MRP ₹ / Unit
F3	50kA	160	830354	17160	830374	21650
F3	50kA	200	830355	20020	830375	27450
F3	50kA	250	830356	28420	830376	35460

optium™
ALL THAT YOU NEED
MCCB

Optium 2.0 (Adjustable Thermal Setting MCCB)

HSN Code: 8536



830385



830386

Frame	Breaking Capacity	Rating	3P	MRP ₹ / Unit	4P	MRP ₹ / Unit
F4	25kA	315	830385	25940	830387	32670
F4	25kA	400	830386	26560	830388	35640
F4	36kA	315	830390	31170	830395	37970
F4	36kA	400	830391	33160	830396	40880
F4	36kA	500	830392	39030	830397	47920
F4	36kA	630	830393	41990	830398	53690
F4	50kA	315	830400	33290	830405	41110
F4	50kA	400	830401	35520	830406	43170
F4	50kA	500	830402	40690	830407	50620
F4	50kA	630	830403	43990	830408	56150

Optium 2.0 (Adjustable Thermal Setting MCCB)

HSN Code: 8536



830410

Frame	Breaking Capacity	Rating	3P	MRP ₹ / Unit	4P	MRP ₹ / Unit
F5	36kA	800	830410	51300	830413	62910
F5	36kA	1000	830411	73890	830414	84520
F5	36kA	1250	830412	85460	830415	101560
F5	50kA	800	830416	52820	830419	75250
F5	50kA	1000	830417	91860	830420	98500
F5	50kA	1250	830418	101310	830421	114090

optium™
ALL THAT YOU NEED
MCCB

Optium 2.1 (Electronic / Micro-Processor MCCB Range)

• Ics =100% Icu as per IEC 60947-II • Class II Front Face • Suitable for Isolation • Adjustable Overload Setting

$I_r = (0.4 - 1) \times I_n$ • Adjustable Short Circuit Current Setting $I_{sd} = 1.5 - 10 \times I_r$

HSN Code: 8536



830430



830431



830432



830433

Frame	Breaking Capacity	Rating	3P	MRP ₹ / Unit	4P	MRP ₹ / Unit
F3	36kA	40	830430	21830	830440	27490
F3	36kA	100	830431	22230	830441	27990
F3	36kA	160	830432	27170	830442	32660
F3	36kA	250	830433	34280	830443	41580
F3	50kA	40	830450	24400	830460	29310
F3	50kA	100	830451	26030	830461	31280
F3	50kA	160	830452	29620	830462	36220
F3	50kA	250	830453	38960	830463	47740

Optium 2.1 (Electronic / Micro-Processor MCCB Range)

• Ics =100% Icu as per IEC 60947-II • Class II Front Face • Suitable For Isolation • Transparent Cover For Trip Unit as Standard • Adjustable Neutral Pole Protection –N,N/2 & Off for 4 Pole MCCB • Innovative Front Indication LED's (Ready, Overload pre-alarm & Overload) • Adjustable Overload Setting $I_r = (0.4 - 1) \times I_n$; $T_r = 3-30$ sec

• Adjustable Short circuit Current Setting $I_{sd} = (1.5 - 10) I_r$; $T_{sd} (I=K) = 0-500$ ms; $T_{sd} (I2t=K) = 0-500$ ms

HSN Code: 8536



830510

Frame	Breaking Capacity	Rating	3P	MRP ₹ / Unit	4P	MRP ₹ / Unit
F4	36kA	400	830510	41390	830512	54590
F4	36kA	630	830511	46640	830513	59260
F4	50kA	400	830514	51170	830516	65080
F4	50kA	630	830515	52990	830517	68700

HSN Code: 8536



830540

Frame	Breaking Capacity	Rating	3P	MRP ₹ / Unit	4P	MRP ₹ / Unit
F5	36kA	800	830540	76410	830542	92650
F5	36kA	1250	830541	114900	830543	146380
F5	50kA	800	830544	81580	830546	101770
F5	50kA	1250	830545	140270	830547	193920

optium™
ALL THAT YOU NEED
MCCB

Optium 2.2 (with Electronic / Micro Processor Release)

• Ics =100% Icu as per IEC 60947-II • Class II Front Face • Suitable for Isolation • Adjustable Overload Setting
 $I_r = (0.4 - 1) \times I_n$ • Adjustable Short Circuit Current Setting $I_{sd} = (1.5 - 10) \times I_r$ • Ground Fault Setting:- $I_g = (0.2 - 1) \times I_n$

HSN Code: 8536



830470

Frame	Breaking Capacity	Rating	3P	MRP ₹ / Unit	4P	MRP ₹ / Unit
F3	36kA	40	830470	25940	830480	32430
F3	36kA	100	830471	26640	830481	33290
F3	36kA	160	830472	29930	830482	37080
F3	36kA	250	830473	38240	830483	47060
F3	50kA	40	830490	28260	830500	34200
F3	50kA	100	830491	29020	830501	34650
F3	50kA	160	830492	33250	830502	40370
F3	50kA	250	830493	43230	830503	52050

Optium 2.2 (Electronic / Micro-Processor MCCB Range)

• Ics =100% Icu as per IEC 60947-II • Class II Front Face • Suitable for Isolation • Transparent Cover for Trip Unit As Standard • Adjustable Neutral Pole Protection –N,N/2 & Off for 4 pole MCCB • Innovative Front Indication LED's (Ready, Overload pre-alarm & Overload) • Adjustable Overload Setting $I_r = (0.4 - 1) \times I_n$; $T_r = 3-30$ sec • Adjustable Short Circuit Current Setting $I_{sd} = (1.5 - 10) I_r$; $T_{sd} (I=K) = 0-500$ ms; $T_{sd} (I2t=K) = 0-500$ ms

HSN Code: 8536



830520

Frame	Breaking Capacity	Rating	3P	MRP ₹ / Unit	4P	MRP ₹ / Unit
F4	36kA	400	830520	55040	830522	65260
F4	36kA	630	830521	62900	830523	80200
F4	50kA	400	830524	61740	830526	71090
F4	50kA	630	830525	69790	830527	89060

HSN Code: 8536



830550

Frame	Breaking Capacity	Rating	3P	MRP ₹ / Unit	4P	MRP ₹ / Unit
F5	36kA	800	830550	95700	830552	120890
F5	36kA	1250	830551	127600	830553	167060
F5	50kA	800	830554	114170	830556	140480
F5	50kA	1250	830555	149430	830557	203540

optium™
ALL THAT YOU NEED
MCCB

Accessories

HSN Code: 8538



830691

Product	Frame	Cat. Nos.	MRP ₹ / Unit
AUXILIARY CONTACT F1 F2 F3	F1 F2 F3	830691	1400
ALARM CONTACT F1 F2 F3	F1 F2 F3	830692	1400
AUXILIARY/ALARM CONTACT F4 F5	F4-F5	830693	1780
AUX./ALARM CONTACT F1 F2 F3	F1 F2 F3	830694	2100

HSN Code: 8538



830602

Product	Frame	Cat. Nos.	MRP ₹ / Unit
SHUNT TRIP 24V AC/DC F1 F2 F3	F1 F2 F3	830602	1590
SHUNT TRIP 110V AC/DC F1 F2 F3	F1 F2 F3	830603	1590
SHUNT TRIP 230V AC/DC F1 F2 F3	F1 F2 F3	830604	1700
SHUNT TRIP 415V AC/DC F1 F2 F3	F1 F2 F3	830605	1700
SHUNT TRIP 24V AC/DC F4 F5	F4 F5	830642	3020
SHUNT TRIP 110V AC/DC F4 F5	F4 F5	830643	3020
SHUNT TRIP 230V AC/DC F4 F5	F4 F5	830644	3020
SHUNT TRIP 415V AC/DC F4 F5	F4 F5	830645	3020

HSN Code: 8538



830606

Product	Frame	Cat. Nos.	MRP ₹ / Unit
UNDERVOLTAGE 24 V DC F1 F2 F3	F1 F2 F3	830606	2610
UNDERVOLTAGE 110V AC F1 F2 F3	F1 F2 F3	830607	2610
UNDERVOLTAGE 230V AC F1 F2 F3	F1 F2 F3	830608	2610
UNDERVOLTAGE 415V AC F1 F2 F3	F1 F2 F3	830609	2610
UNDERVOLTAGE 24 V DC F4 F5	F4 F5	830646	2690
UNDERVOLTAGE 110V AC F4 F5	F4 F5	830647	2690
UNDERVOLTAGE 230V AC F4 F5	F4 F5	830648	2690
UNDERVOLTAGE 415V AC F4 F5	F4 F5	830649	2690

optium™
ALL THAT YOU NEED
MCCB

Accessories

HSN Code: 8538

	Product	Frame	Cat. Nos.	MRP ₹ / Unit
 <p>830611</p> <p>830626</p>	Rotary Handle Direct	F1	830611	2000
	Rotary Handle vary-Depth	F1	830612	2000
	Rotary Handle Direct	F2 F3	830626	2270
	Rotary Handle vary-Depth	F2 F3	830627	2270
	Rotary Handle Direct	F4	830651	2690
	Rotary Handle vary-Depth	F4	830652	2690
	Rotary Handle Direct	F5	830671	5260
	Rotary Handle vary-Depth	F5	830672	5260

HSN Code: 8538

	Product	Frame	Cat. Nos.	MRP ₹ / Unit
 <p>830613</p>	Ronis lock Direct RH	F1 F2 F3	830613	2190
	Ronis lock Vary-Depth RH	F1 F2 F3	830614	2190
	Ronis lock Vary-Depth RH	F4	830653	2860

HSN Code: 8538

	Product	Frame	Cat. Nos.	MRP ₹ / Unit
 <p>830615</p>	Padlock Off position	F1 F2 F3	830615	2980
	Padlock Off position	F4	830654	2880
	Padlock Off position	F5	830674	2880

Accessories

HSN Code: 8538



830616



830628

Product	Frame	Cat. Nos.	MRP ₹ / Unit
PHASE INSULATOR 3P F1 F2	F1 F2	830616	470
PHASE INSULATOR 3P F3	F3	830628	560
PHASE INSULATOR 3P F4	F4	830655	980
PHASE INSULATOR 3P F5	F5	830675	1330
PHASE INSULATOR 4P F1 F2	F1 F2	830617	710
PHASE INSULATOR 4P F3	F3	830629	700
PHASE INSULATOR 4P F4	F4	830656	1200
PHASE INSULATOR 4P F5	F5	830676	1570

HSN Code: 8538





830657

Product	Frame	Cat. Nos.	MRP ₹ / Unit
TERMINAL COVER 3P F4	F4	830657	1200
TERMINAL COVER 3P F5	F5	830677	1770
TERMINAL COVER 4P F4	F4	830658	1770
TERMINAL COVER 4P F5	F5	830678	2350
TERMINAL SHIELD 3P F5	F5	830679	2750
TERMINAL SHIELD 4P F5	F5	830680	3730

optium™
ALL THAT YOU NEED
MCCB

Accessories

HSN Code: 8538

		Product	Frame	Cat. Nos.	MRP ₹ / Unit
 <p>830618</p>	Spreaders 3P	F1	830618	540	
	Spreaders 4P	F1	830619	790	
	Spreaders 3P	F2 F3	830632	1350	
	Spreaders 4P	F2 F3	830633	2700	
	Spreaders 3P	F4	830659	4280	
	Spreaders 4P	F4	830660	6240	
 <p>830619</p>	Spreaders 3P 800/1000A	F5	830681	11050	
	Spreaders 4P 800/1000A	F5	830682	16770	
	Spreaders 3P 1250A	F5	830685	11500	
	Spreaders 4P 1250A	F5	830686	16950	

HSN Code: 8538

		Product	Frame	Cat. Nos.	MRP ₹ / Unit
 <p>830620</p>	Cages 3P upto 50A	F1	830620	610	
	Cages 4P upto 50A	F1	830621	820	
	Cages 3P 63 to 100A	F1	830622	610	
	Cages 4P 63 to 100A	F1	830623	820	
	Cages 3P 125A	F1	830624	610	
	Cages 4P 125A	F1	830625	820	
 <p>830621</p>	Cages 3P	F2	830630	800	
	Cages 4P	F2	830631	940	
	Cages 3P	F3	830634	1050	
	Cages 4P	F3	830635	1400	
	Cages 3P	F4	830661	1480	
	Cages 4P	F4	830662	1570	
	Cages 3P	F5	830683	1610	
	Cages 4P	F5	830684	1730	

A versatile and reliable solution

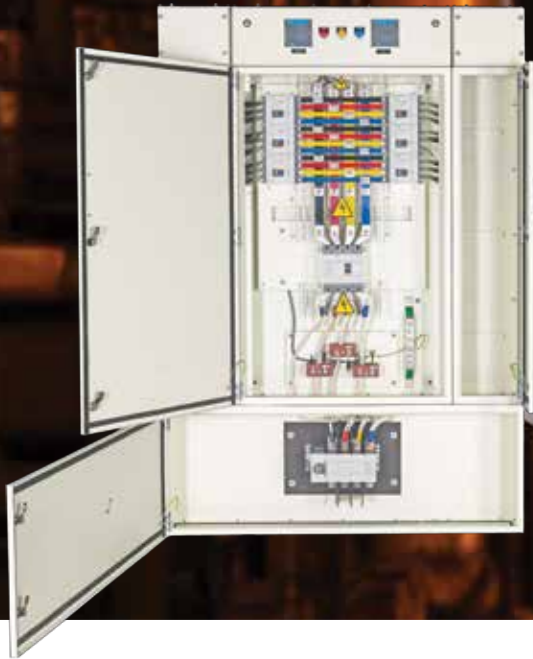

Scan to know more about the product

Optipro SMDBs are designed for safe power distribution in residential, commercial & industrial installations. With sturdy construction and smart internal designs it delivers safe, organised, and efficient electrical distribution.

Features

- Twin packaging with removable shields for dust-free construction and easy post-wiring access
- The system offers customizable add-ons such as metering units, cable alleys, corner units, and switchgear combinations with ratings up to 800A for different load requirements
- Ergonomic sliding knobs, airflow channels in MCCBs, and multiple knockouts for cabling flexibility

Benefits

- Easy project execution through factory-ready enclosures, cement spill protectors, and modular designs
- Ensures complete safety with true IP43 protection, isolated neutral bars, and zero live part exposure
- Durable performance in harsh environments through high endurance components and weather-resistant finishes

—optipro™ SMDB—

Optipro SMDB 250 (Single Door) - Main Enclosure (With a provision to mount TP MCCBs as an outgoing*)

• Tested as per IEC 61439-2 • Degree of protection IP-30 in Single door & IP-43 in Double door **HSN Code: 8536**



812100

Item Description	Type	Cat. Nos.	MRP ₹ / Unit
SMDB250 4W SD ME Optium F2-I/c & TP F1 O/G	SD	812100	44020
SMDB250 6W SD ME Optium F2-I/c & TP F1 O/G	SD	812101	47260
SMDB250 8W SD ME Optium F2-I/c & TP F1 O/G	SD	812102	54280
SMDB250 12W SD ME Optium F2-I/c & TP F1 O/G	SD	812103	64150
SMDB250 4W SD ME Optium F3-I/c & TP F1 O/G	SD	812110	47830
SMDB250 6W SD ME Optium F3-I/c & TP F1 O/G	SD	812111	51350
SMDB250 8W SD ME Optium F3-I/c & TP F1 O/G	SD	812112	58980
SMDB250 12W SD ME Optium F3-I/c & TP F1 O/G	SD	812113	69730

Optipro SMDB 250 (Single Door) - Main Enclosure (With a provision to mount TP MCCBs as an outgoing*)

HSN Code: 8536



812120

Item Description	Type	Cat. Nos.	MRP ₹ / Unit
SMDB400 4W SD ME Optium F4-I/c & TP F1 O/G	SD	812120	49220
SMDB400 6W SD ME Optium F4-I/c & TP F1 O/G	SD	812121	52810
SMDB400 8W SD ME Optium F4-I/c & TP F1 O/G	SD	812122	60830
SMDB400 12W SD ME Optium F4-I/c & TP F1 O/G	SD	812123	71890

*Consider the cost of MCCBs separately

—optipro™ SMDB—

Optipro SMDB 630 (Single Door) - Main Enclosure (With a provision to mount TP MCCBs as an outgoing*)

HSN Code: 8536



812136

Item Description	Type	Cat. Nos.	MRP ₹ / Unit
SMDB630 4W SD ME Optium F4-1/c & TP F1 O/G	SD	812136	73830
SMDB630 6W SD ME Optium F4-1/c & TP F1 O/G	SD	812137	76590
SMDB630 8W SD ME Optium F4-1/c & TP F1 O/G	SD	812138	88210
SMDB630 12W SD ME Optium F4-1/c & TP F1 O/G	SD	812139	104240
SMDB630 8W SD ME Optium F4-1/c & TP F1-6 & F2-2 O/G	SD	812140	88210
SMDB630 12W SD ME Optium F4-1/c & TP F1-10 & F2-2 O/G	SD	812142	104240

Optipro SMDB 250 (Single Door) - Main Enclosure (With a provision to mount TP MCCBs as an outgoing*)

HSN Code: 8536



Item Description	Type	Cat. Nos.	MRP ₹ / Unit
SMDB250 4W SD ME Optium F2-1/c & FP F1 O/G	SD	812105	48420
SMDB250 6W SD ME Optium F2-1/c & FP F1 O/G	SD	812106	51960
SMDB250 8W SD ME Optium F2-1/c & FP F1 O/G	SD	812107	59730
SMDB250 12W SD ME Optium F2-1/c & FP F1 O/G	SD	812108	70790
SMDB250 4W SD ME Optium F3-1/c & FP F1 O/G	SD	812115	52620
SMDB250 6W SD ME Optium F3-1/c & FP F1 O/G	SD	812116	56520
SMDB250 8W SD ME Optium F3-1/c & FP F1 O/G	SD	812117	64900
SMDB250 12W SD ME Optium F3-1/c & FP F1 O/G	SD	812118	76920

*Consider the cost of MCCBs separately

—optipro™ SMDB—

Optipro SMDB 400 (Single Door) - Main Enclosure (With a provision to mount TP MCCBs as an outgoing*)

HSN Code: 8536



Item Description	Type	Cat. Nos.	MRP ₹ / Unit
SMDB400 4W SD ME Optium F4-I/c & FP F1 O/G	SD	812128	54190
SMDB400 6W SD ME Optium F4-I/c & FP F1 O/G	SD	812129	58340
SMDB400 8W SD ME Optium F4-I/c & FP F1 O/G	SD	812130	66920
SMDB400 12W SD ME Optium F4-I/c & FP F1 O/G	SD	812131	79360

Optipro SMDB 630 (Single Door) - Main Enclosure (With a provision to mount TP MCCBs as an outgoing*)

HSN Code: 8536

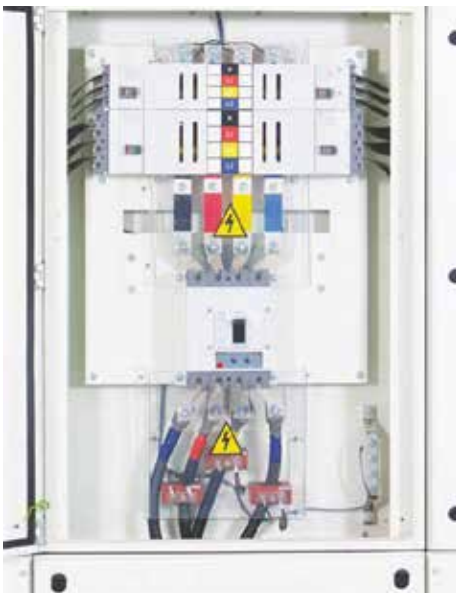

Item Description	Type	Cat. Nos.	MRP ₹ / Unit
SMDB630 4W SD ME Optium F4-I/c & FP F1 O/G	SD	812144	81300
SMDB630 6W SD ME Optium F4-I/c & FP F1 O/G	SD	812145	84610
SMDB630 8W SD ME Optium F4-I/c & FP F1 O/G	SD	812146	97050
SMDB630 12W SD ME Optium F4-I/c & FP F1 O/G	SD	812147	115030
SMDB630 8W SD ME Optium F4-I/c & FP F1-6 & F2-2 O/G	SD	812148	97050
SMDB630 12W SD ME Optium F4-I/c & FP F1-10 & F2-2 O/G	SD	812150	115030

*Consider the cost of MCCBs separately

—optipro™ SMDB—

Optipro SMDB 250 (Double Door) - Main Enclosure (With a provision to mount TP MCCBs as an outgoing*)

HSN Code: 8536



812181



812182

Item Description	Type	Cat. Nos.	MRP ₹ / Unit
SMDB250 4W DD ME Optium F2-I/c & TP F1 O/G	DD	812181	52150
SMDB250 6W DD ME Optium F2-I/c & TP F1 O/G	DD	812182	56220
SMDB250 8W DD ME Optium F2-I/c & TP F1 O/G	DD	812183	64620
SMDB250 12W DD ME Optium F2-I/c & TP F1 O/G	DD	812184	76180
SMDB250 4W DD ME Optium F3-I/c & TP F1 O/G	DD	812191	54560
SMDB250 6W DD ME Optium F3-I/c & TP F1 O/G	DD	812192	58760
SMDB250 8W DD ME Optium F3-I/c & TP F1 O/G	DD	812193	67580
SMDB250 12W DD ME Optium F3-I/c & TP F1 O/G	DD	812194	79630

Optipro SMDB 400 (Double Door) - Main Enclosure (With a provision to mount TP MCCBs as an outgoing*)

HSN Code: 8536



812201

Item Description	Type	Cat. Nos.	MRP ₹ / Unit
SMDB400 4W DD ME Optium F4-I/c & TP F1 O/G	DD	812201	56130
SMDB400 6W DD ME Optium F4-I/c & TP F1 O/G	DD	812202	60560
SMDB400 8W DD ME Optium F4-I/c & TP F1 O/G	DD	812203	69680
SMDB400 12W DD ME Optium F4-I/c & TP F1 O/G	DD	812204	82120

*Consider the cost of MCCBs separately

—optipro[™] SMDB—

Optipro SMDB 630 (Double Door) - Main Enclosure (With a provision to mount TP MCCBs as an outgoing*)

HSN Code: 8536



812220

Item Description	Type	Cat. Nos.	MRP ₹ / Unit
SMDB630 4W DD ME Optium F4-l/c & TP F1 O/G	DD	812217	84330
SMDB630 6W DD ME Optium F4-l/c & TP F1 O/G	DD	812218	87930
SMDB630 8W DD ME Optium F4-l/c & TP F1 O/G	DD	812219	100920
SMDB630 12W DD ME Optium F4-l/c & TP F1 O/G	DD	812220	119170
SMDB630 8W DD ME Optium F4-l/c & TP F1-6 & F2-2 O/G	DD	812221	100920
SMDB630 12W DD ME Optium F4-l/c & TP F1-10 & F2-2 O/G	DD	812223	119170

Optipro SMDB 250 (Double Door) - Main Enclosure (With a provision to mount TP MCCBs as an outgoing*)

HSN Code: 8536



812186

Item Description	Type	Cat. Nos.	MRP ₹ / Unit
SMDB250 4W DD ME Optium F2-l/c & FP F1 O/G	DD	812186	57370
SMDB250 6W DD ME Optium F2-l/c & FP F1 O/G	DD	812187	61830
SMDB250 8W DD ME Optium F2-l/c & FP F1 O/G	DD	812188	71090
SMDB250 12W DD ME Optium F2-l/c & FP F1 O/G	DD	812189	83980
SMDB250 4W DD ME Optium F3-l/c & FP F1 O/G	DD	812196	60060
SMDB250 6W DD ME Optium F3-l/c & FP F1 O/G	DD	812197	64650
SMDB250 8W DD ME Optium F3-l/c & FP F1 O/G	DD	812198	74330
SMDB250 12W DD ME Optium F3-l/c & FP F1 O/G	DD	812199	87760

*Consider the cost of MCCBs separately

—optipro™ SMDB—

Optipro SMDB 400 (Double Door) - Main Enclosure (With a provision to mount TP MCCBs as an outgoing*)

HSN Code: 8536



812209

Item Description	Type	Cat. Nos.	MRP ₹ / Unit
SMDB400 4W DD ME Optium F4-I/c & FP F1 O/G	DD	812209	61940
SMDB400 6W DD ME Optium F4-I/c & FP F1 O/G	DD	812210	66640
SMDB400 8W DD ME Optium F4-I/c & FP F1 O/G	DD	812211	76590
SMDB400 12W DD ME Optium F4-I/c & FP F1 O/G	DD	812212	90420

Optipro SMDB 630 (Double Door) - Main Enclosure (With a provision to mount TP MCCBs as an outgoing*)

HSN Code: 8536



812225



812227

Item Description	Type	Cat. Nos.	MRP ₹ / Unit
SMDB630 4W DD ME Optium F4-I/c & FP F1 O/G	DD	812225	92910
SMDB630 6W DD ME Optium F4-I/c & FP F1 O/G	DD	812226	96500
SMDB630 8W DD ME Optium F4-I/c & FP F1 O/G	DD	812227	11160
SMDB630 12W DD ME Optium F4-I/c & FP F1 O/G	DD	812228	131070
SMDB630 8W DD ME Optium F4-I/c & FP F1-6 & F2-2 O/G	DD	812229	11160
MDB630 12W DD ME Optium F4-I/c & FP F1-10 & F2-2 O/G	DD	812231	131070

*Consider the cost of MCCBs separately

—optipro™ SMDB—

Optipro SMDB - Bottom Cable Unit (Single Door)

HSN Code: 8536



812152

Item Description	Type	Cat. Nos.	MRP ₹ / Unit
Bottom Cable Unit(for SD SMDB's with F1 O/G only)	SD	812152	5280
Bottom Cable Unit(for SD SMDB's with F1 & F2 O/G)	SD	812153	5950

Optipro SMDB 250 - Cable Alley Unit (Single Door)

HSN Code: 8536



812154

Item Description	Type	Cat. Nos.	MRP ₹ / Unit
SMDB250 Cable Alley-4W SD	SD	812154	12500
SMDB250 Cable Alley-6W SD	SD	812155	14740
SMDB250 Cable Alley-8W SD	SD	812156	15930
SMDB250 Cable Alley-12W SD	SD	812157	17950

Optipro SMDB 400/630 - Cable Alley (Single Door)

HSN Code: 8536



812159

Item Description	Type	Cat. Nos.	MRP ₹ / Unit
SMDB400/630 Cable Alley-4W DD	SD	812159	17420
SMDB400/630 Cable Alley-6W DD	SD	812160	19190
SMDB400/630 Cable Alley-8W DD	SD	812161	20770
SMDB400/630 Cable Alley-12W DD	SD	812162	22760
SMDB400/630 Cable Alley-8W DD	SD	812163	20770
SMDB400/630 Cable Alley-12W DD	SD	812164	22760
SMDB400/630 Cable Alley-12W DD	SD	812165	22760

—optipro™ SMDB—

Optipro SMDB 400/630 - Cable Alley (Single Door)

HSN Code: 8536



812167

Item Description	Type	Cat. Nos.	MRP ₹ / Unit
Metering Unit(for DD SMDB's with F1 O/G only)- with Ammeter,Voltmeter & Phase Indicators(3nos.)	SD	812167	17480
Metering Unit (for DD SMDB's with F1 & F2 O/G) - with Ammeter,Voltmeter & Phase Indicators(3nos.)	SD	812168	18940
Metering Unit(for DD SMDB's with F1 O/G only)- with Multi-function meter, Buzzer & Phase Indicators(3nos.)	SD	812169	21840
Metering Unit (for SD SMDB's with F1 & F2 O/G) - with Multi-function meter, Buzzer & Phase Indicators(3nos.)	SD	812170	23700
Corner Unit-SD	SD	812171	2100

Optipro SMDB - Bottom Cable Unit (Double Door)

HSN Code: 8536

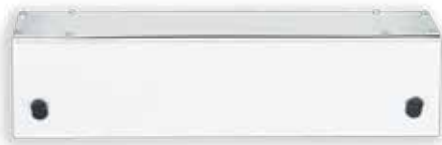

812233

Item Description	Type	Cat. Nos.	MRP ₹ / Unit
Bottom Cable Unit(for DD SMDB's with F1 O/G only)		812233	5920
Bottom Cable Unit(for DD SMDB's with F1 & F2 O/G)		812234	6670

Optipro SMDB 250 - Cable Alley Unit (Single Door)

HSN Code: 8536



812236

Item Description	Type	Cat. Nos.	MRP ₹ / Unit
SMDB250 Cable Alley-6W DD	DD	812236	16510
SMDB250 Cable Alley-8W DD	DD	812237	17840
SMDB250 Cable Alley-12W DD	DD	812238	20100

—optipro™ SMDB—

Optipro SMDB 400/630- Cable Alley Unit (Double Door)

HSN Code: 8536



812240



812241

Item Description	Type	Cat. Nos.	MRP ₹ / Unit
SMDB400/630 Cable Alley-4W DD	DD	812240	19520
SMDB400/630 Cable Alley-6W DD	DD	812241	21510
SMDB400/630 Cable Alley-8W DD	DD	812242	23260
SMDB400/630 Cable Alley-12W DD	DD	812243	25490
SMDB400/630 Cable Alley-8W DD	DD	812244	23260
SMDB400/630 Cable Alley-12W DD	DD	812245	25490
SMDB400/630 Cable Alley-12W DD	DD	812246	25490
Metering Unit(for DD SMDB's with F1 O/G only)- with Ammeter,Voltmeter & Phase Indicators(3nos.)	DD	812248	22730
Metering Unit (for DD SMDB's with F1 & F2 O/G) - with Ammeter,Voltmeter & Phase Indicators(3nos.)	DD	812249	24610
Metering Unit(for DD SMDB's with F1 O/G only)- with Multifunction meter, Buzzer & Phase Indicators(3nos.)	DD	812250	28400
Metering Unit (for SD SMDB's with F1 & F2 O/G) - with Multifunction meter, Buzzer & Phase Indicators(3nos.)	DD	812251	30750
Corner Unit-SD	DD	812252	2100

Switch on to a reliable partner

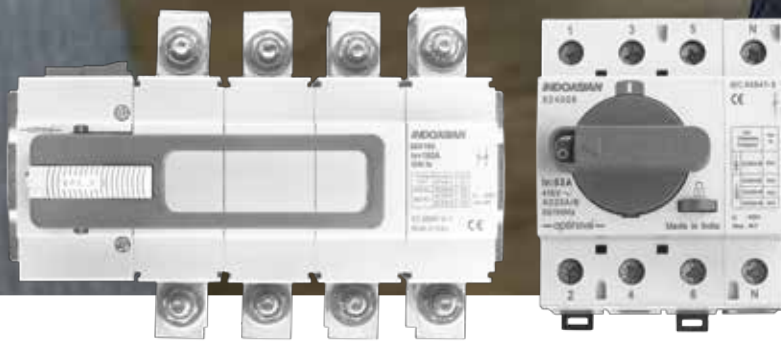

Scan to know more about the product

Optinova provides low-voltage switch disconnectors and transfer switching solutions for safe circuit isolation and reliable power changeover in buildings, industries, and infrastructure.

Features

- Clear indication of mechanism with rotary handles and a padlock for safety
- IP20 protected internal mechanism with DIN-rail or plate mounting options
- High short-time withstand capacity (I_{cw}) and ratings up to 320 A

Benefits

- Simplifies installation & maintenance with compact form factor & snap-fit auxiliaries
- Ensures safe isolation and source changeover, reducing risk of accidents
- Delivers high reliability & uptime through robust design & high short-time withstand ratings

— optinova™ —

**4P Switch Disconnecter / Transfer Switching
Equipment - Din Frame**

HSN Code: 8536



824006

Rated Current	Cat. Nos.	Description	MRP ₹ / Unit
32A	824006	SD DIN OPTI 63 4P 32A	2640
40A	824007	SD DIN OPTI 63 4P 40A	2790
63A	824008	SD DIN OPTI 63 4P 63A	3310

**4P Switch Disconnecter / Transfer Switching
Equipment - Power Frame**

HSN Code: 8536

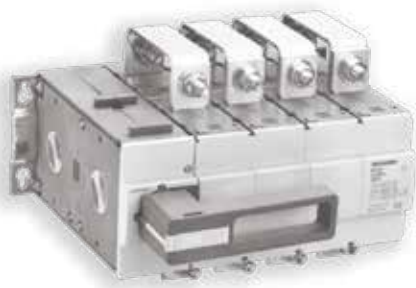

824082

Rated Current	Cat. Nos.	Description	MRP ₹ / Unit
63A	824082	SD PLATE OPTI 160 4P 63A KIT	4610
100A	824083	SD PLATE OPTI 160 4P 100A KIT	6430
125A	824084	SD PLATE OPTI 160 4P 125A KIT	6950
160A	824085	SD PLATE OPTI 160 4P 160A KIT	8810
200A	824086	SD PLATE OPTI 320 4P 200A KIT	11020
250A	824087	SD PLATE OPTI 320 4P 250A KIT	13840
320A	824088	SD PLATE OPTI 320 4P 320A KIT	15370

**4P Switch Disconnecter / Transfer Switching
Equipment - Din Frame**

HSN Code: 8536



824106

Rated Current	Cat. Nos.	Description	MRP ₹ / Unit
32A	824106	TSE DIN OPTI 63 4P 32A	4980
40A	824107	TSE DIN OPTI 63 4P 40A	5570
63A	824108	TSE DIN OPTI 63 4P 63A	6210

— optinova™ —

**4P Switch Disconnecter / Transfer Switching
Equipment - Power Frame**

HSN Code: 8536

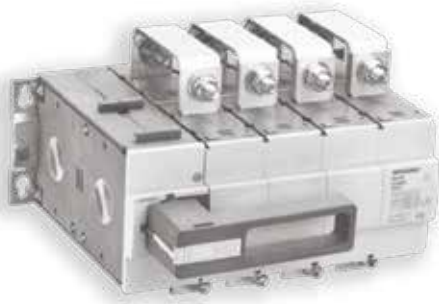

824182

Rated Current	Cat. Nos.	Description	MRP ₹ / Unit
63A	824182	TSE PLATE OPTI 160 4P 63A KIT	7240
100A	824183	TSE PLATE OPTI 160 4P 100A KIT	9010
125A	824184	TSE PLATE OPTI 160 4P 125A KIT	13520
160A	824185	TSE PLATE OPTI 160 4P 160A KIT	15070
200A	824186	TSE PLATE OPTI 320 4P 200A KIT	18010
250A	824187	TSE PLATE OPTI 320 4P 250A KIT	25760
320A	824188	TSE PLATE OPTI 320 4P 320A KIT	27440

**4P Switch Disconnecter / Transfer Switching
Equipment - Power Frame**

HSN Code: 8536

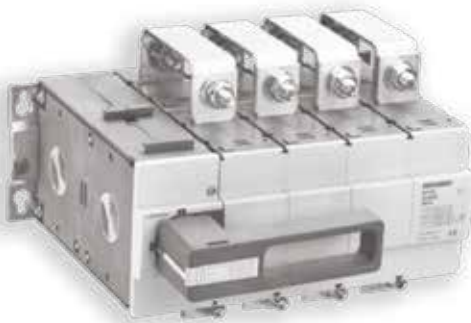

824192

Rated Current	Cat. Nos.	Description	MRP ₹ / Unit
63A	824192	TSE PLATE OPTI 160 4P 63A ENC	10540
100A	824193	TSE PLATE OPTI 160 4P 100A ENC	13780
125A	824194	TSE PLATE OPTI 160 4P 125A ENC	19360
160A	824195	TSE PLATE OPTI 160 4P 160A ENC	21280
200A	824196	TSE PLATE OPTI 320 4P 200A ENC	24740
250A	824197	TSE PLATE OPTI 320 4P 250A ENC	32940
320A	824198	TSE PLATE OPTI 320 4P 320A ENC	35510

— optinova™ —
Accessories - DIN Frame
HSN Code: 8538

824201

Product	Cat. Nos.	Description	MRP ₹ / Unit
Shorting links 63A for TSE	824201	OPTI Shorting links F1 4P DIN	950
Auxiliary contact Simultaneous (1 NO + 1 NC)	824208	OPTI Auxcont 1No+1NC F1&2 DIN	500
Handle Vary Depth KIT IP54	824209	OPTI Handle Depth KIT F1&2DIN	1400
SD Direct Handle	824215	OPTI Handle Direct F1&2 DIN	1120
TSE Direct Handle	824217	OPTI TSE Handle Dir F1&2DIN	1120

Accessories - Frame 2- 320A
HSN Code: 8538

824230

Product	Cat. Nos.	Description	MRP ₹ / Unit
Handle Direct	824230	OPTI Handle Direct	1170
Handle Vary Depth	824231	OPTI Handle Vary Depth	1670
Spreader terminals (one side only)	824238	OPTI Sprder termi F2 4P_1Side	2180
Inter source barrier for TSE	824239	OPTI Intersourcebar F2(3P&4P)	450
Shorting Link for TSE	824241	OPTI Linking bridge-4P	4010
Phase Barriers	824243	OPTI Phase Barriers F2 4P	280
Aux contact Simultaneous (4 NO + 4 NC)	824245	OPTI Auxcontact SimulTan F1&2	1400

Accessories - Frame 1- 160A
HSN Code: 8538

824249

Product	Cat. Nos.	Description	MRP ₹ / Unit
Shorting Link for TSE	824249	OPTI Linking bridge-4P	2680
Phase Barriers	824251	OPTI Phase Barriers F1 4P	220
Inter source barrier for TSE	824252	OPTI Intersourcebar F1(3P&4P)	280
Spreader terminals (one side only)	824254	OPTI Sprder termi F1 4P-1Side	1090

— optinova™ —

HRC Fuse Links & Bases

Bolted Type (BS) Breaking Capacity ≥ 80kA 500 V AC 50 Hz.

HSN Code: 8536



Rating	Type	Cat. Nos.	Tag Type	MRP ₹ / Unit	Unit/Carton
2, 4, 6, 8, 10, 16A	FGN	IEFGN***	Offset	110	20
20, 25, 32A	FGN	IEFGN***	Offset	110	20
2, 4, 6, 10, 16, 20, 25, 32A	FSA	IEFSA***	Offset	170	10
35, 40, 50, 63A	FSS	IEFSS***	Offset	190	10
50, 63, 80, 100, 125, 160A	FSDCP	IEDCP***	Offset	410	10
100, 125, 160, 200, 250A	FSFP	IESFP***	Offset	580	3
50, 63, 80, 100, 125A	FSDC	IESDC***	Central	410	10
100, 125, 160, 200, 250A	FSF	IEFSF***	Central	600	3
225, 250, 300, 315, 320A	FSK	IEFSK***	Central	860	3
355, 400A	FMF	IEFMF***	Central	1660	3
355, 400, 450, 500, 560, 600, 630A	FTS	IEFTS***	Central	1920	1
355, 400, 450, 500, 560A	FTM	IEFTM***	2 Central	2480	1
600, 630A	FTM	IEFTM***	2 Central	2480	1

DIN Type Breaking Capacity ≥ 80kA 500 V AC 50 Hz.

HSN Code: 8536



Rating	Type	Cat. Nos.	Tag Type	MRP ₹ / Unit	Unit/Carton
2, 4, 6, 10, 16, 20, 25, 32, 50, 63A	Size 000	IWS00***	6	510	6
2, 4, 6, 10, 16, 20, 25, 32, 36, 40, 50, 63A	Size 00	IW000***	6	119	6
80, 100A		IW000***	6	119	6
125, 160A		IW000***	6	119	6
32, 36, 50, 63, 80, 100, 125, 160, 200A	Size 01	IW001***	3	130	3
250A		IW001***	3	130	3
100, 125, 160, 200, 250, 315A	Size 02	IW002***	3	1450	3
400A		IW002***	3	1450	3
315, 355, 400, 425A	Size 03	IW003***	3	1990	3
500, 630A		IW003***	3	1990	3

*HRC fuses with SC breaking capacity 120kA are available on request.

— optinova™ —

Cylindrical Type (IFRH) Breaking Capacity > 80kA 415 V AC.

HSN Code: 8536



Rating Amps	Cat. Nos.	MRP ₹ / Unit
2 to 25A	IFRHO***	220
32 to 40A	IFRHO***	220
50A	IFRH0050	420
63A	IFRH0063	430
Fuse Holder Fr type (2 to 63A)	IFR00***	400

Fuse Fittings For Bolted (BS) Type

HSN Code: 8536

Rating Amps	Front Connection	MRP ₹ / Unit
20A	BFBC0020	260
32A	BFBC0032	440
63A	BFBC0063	650
100A	BFBC0100	1620
20A (Stud Type)	BFFCS020	350

Bolted Type (BS) Breaking Capacity ≥ 80kA 500 V AC 50 Hz.

HSN Code: 8536



Rating	Type	Cat. Nos.	MRP ₹ / Unit	Unit/Carton
6-160A	Size - 00	IWFBO***	POR**	6
32-250A	Size - 1	IWFB1***	1320	2
100-400A	Size - 2	IWFB2***	1980	2
315-630A	Size - 3	IWFB3***	2510	2

**POR - Price on Request

— optinova™ —

Switch Disconnecter Fuses

HSN Code: 8536

Rated Current	Type	IN OPEN EXECUTION*		IN SHEET STEEL ENCLOSURE		Recommended HRC Fuse IndoAsian Make
		Cat. Nos.	MRP ₹ / Unit	Cat. Nos.	MRP ₹ / Unit	
32A BS	TPN	INO1A032	2630	INS1A032	5370	FSA
63A BS	TPN	INO1A063	3640	INS1A063	6850	FSS
100A BS	TPN	INO1A100	8010	INS1A100	11210	FSDCP
125A BS	TPN	INO1A125	8990	INS1A125	13430	FSDCP
160A BS	TPN	INO1A160	10880	INS1A160	15000	FSDCP
200A BS	TPN	INO1A200	13540	INS1A200	17440	FSF
250A BS	TPN	INO1A250	15280	INS1A250	20170	FSF
315A BS	TPN	INO1A315	19580	INS1A315	25180	FSK
400A BS	TSPN	INO1A400	24300	INS1A400	30050	FMF
32A BS	TSPN	INO1B032	3350	INS1B032	5670	FSA
63A BS	TSPN	INO1B063	4250	INS1B063	6700	FSS
100A BS	TSPN	INO1B100	9850	INS1B100	12550	FSDCP
125A BS	TSPN	INO1B125	10790	INS1B125	13430	FSDCP
160A BS	TSPN	INO1B160	13490	INS1B160	17360	FSDCP
200A BS	TSPN	INO1B200	15360	INS1B200	19210	FSF
250A BS	TSPN	INO1B250	16750	INS1B250	21560	FSF
315A BS	TSPN	INO1B315	23700	INS1B315	30120	FSK
400A BS	TSPN	INO1B400	28040	INS1B400	31330	FMF



*Price does not include HRC Fuse

Ambidex

Switch Disconnecter Fuses

HSN Code: 8536



Rated Current	Type	IN OPEN EXECUTION*		IN SHEET STEEL ENCLOSURE		Recommended HRC Fuse IndoAsian Make
		Cat. Nos.	MRP ₹ / Unit	Cat. Nos.	MRP ₹ / Unit	
32A DIN	TPN	IN1OA032	2770	IN1SA032	5110	Size 000
63A DIN	TPN	IN1OA063	3840	IN1SA063	6500	Size 000
100A DIN	TPN	IN1OA100	8210	IN1SA100	11080	Size 00
125A DIN	TPN	IN1OA125	9380	IN1SA125	13390	Size 00
160A DIN	TPN	IN1OA160	11290	IN1SA160	14710	Size 00
200A DIN	TPN	IN1OA200	14100	IN1SA200	16740	Size 01
250A DIN	TPN	IN1OA250	15790	IN1SA250	20150	Size 01
315A DIN	TPN	IN1OA315	20280	IN1SA315	25090	Size 02
400A DIN	TPN	IN1OA400	25000	IN1SA400	29740	Size 02
630A DIN	TPN	IN1OA630	39380	IN1SA630	42410	Size 03
800A DIN	TPN	IN1OA800	48020	IN1SA800	60040	Size 03
32A DIN	TSPN	IN1OB032	3920	IN1SB032	5260	Size 000
63A DIN	TSPN	IN1OB063	4520	IN1SB063	5680	Size 000
100A DIN	TSPN	IN1OB100	10130	IN1SB100	11340	Size 00
125A DIN	TSPN	IN1OB125	11220	IN1SB125	12200	Size 00
160A DIN	TSPN	IN1OB160	13150	IN1SB160	16310	Size 00
200A DIN	TSPN	IN1OB200	15280	IN1SB200	17210	Size 01
250A DIN	TSPN	IN1OB250	17500	IN1SB250	19720	Size 01
315A DIN	TSPN	IN1OB315	23430	IN1SB315	26830	Size 02
400A DIN	TSPN	IN1OB400	27230	IN1SB400	33500	Size 02
630A DIN	TSPN	IN1OB630	43710	IN1SB630	45820	Size 03
800A DIN	TSPN	IN1OB800	50540	IN1SB800	66040	Size 03

*Price does not include HRC Fuse

Ambidex

HSN Code: 8536

Rated Current	IN OPEN EXECUTION*		IN SHEET STEEL ENCLOSURE	
	Cat. Nos.	MRP ₹ / Unit	Cat. Nos.	MRP ₹ / Unit
400A	INISD400	19930	IN3ED400	31520
630A	INISD630	27650	IN4ED630	45980
800A	INISD800	32930	IN4ED800	53260

*Prices of 3 Pole SD is available on Request.

Changeover Switches

On-Load Changeover Switches 4 Pole

HSN Code: 8536

Rated Current	IN OPEN EXECUTION*		IN SHEET STEEL ENCLOSURE	
	Cat. Nos.	MRP ₹ / Unit	Cat. Nos.	MRP ₹ / Unit
400A	ICAE0400	42060	ICAS0400	66070
630A	ICAE0630	49550	ICAS0630	70800
800A	ITAE0800	69440	ITAS0800	104220
1000A	ITAE1000	125610	ITAS1000	174680
1250A	ITAE1250	168570	ITAS1250	241150
1600A	ITAE1600	193570	ITAS1600	319980
2000A	ITAE2000	283060	ITAS2000	394250
2500A	ITAE2500	389430	ITAS2500	522950
3150A	ITAE3150	400230	ITAS3150	678870



Ambidex

Changeover Switches

On-Load Changeover Switches 4 Pole

HSN Code: 8536

Rating Amps	Cat. Nos.	MRP ₹ / Unit
Aux.Switch 200A-630A(1NO+1NC)	ICAO0AUX	290
SPREADER LINK FRAME00-4 LINKS	ICAO0SPL	460

On-Load Switch Fuse Changeover

HSN Code: 8536



IN OPEN EXECUTION*			IN SHEET STEEL ENCLOSURE	
Rated Current	Cat. Nos.	MRP ₹ / Unit	Cat. Nos.	MRP ₹ / Unit
125A	ITBE0125	19610	ITBS0125	29970
200A	ITBE0200	35830	ITBS0200	53200
250A	ITBE0250	36170	ITBS0250	53700
320A	ITBE0320	37340	ITBS0320	55440
400A	ITBE0400	54090	ITBS0400	80300
630A	ITBE0630	63130	ITBS0630	93720

*Price does not include HRC Fuse

On-Load By-Pass Switches

HSN Code: 8536

IN OPEN EXECUTION*			IN SHEET STEEL ENCLOSURE	
Rated Current	Cat. Nos.	MRP ₹ / Unit	Cat. Nos.	MRP ₹ / Unit
125A	ITCE0125	27900	ITCS0125	37670
200A	ITCE0200	35530	ITCS0200	47960
250A	ITCE0250	51610	ITCS0250	69680
320A	ITCE0320	53590	ITCS0320	72350
400A	ITCE0400	80390	ITCS0400	108530
630A	ITCE0630	91330	ITCS0630	123300

*Price does not include HRC Fuse

Ambidex

Off Load Changeover Switch

HSN Code: 8536



- With enclosure
- Rated Voltage - 415V-AC 50Hz
- Type - FP

Rating	Cat. Nos.	Cat. Nos.	MRP ₹ / Unit
32A (DP)	OFDP0032	2352	2530
16A	OFFP0016	3766	4050
32A	OFFP0032	3931	4230
63A	OFFP0063	7991	8590
100A	OFFP0100	15616	16780
125A	OFFP0125	21952	23590
200A	OFFP0200	23701	25470
250A	OFFP0250	30191	32450
315A	OFFP0315	31167	33500
400A	OFFP0400	36359	39080

*Prices for spares of Rewirable Switch Fuse Unit like Action Bar, Base Plate, End Shield, Bakelite Contact Shrouds are available on request.

Add a touch of shine to your life



Shynora provides modular wiring device range blending elegant design with functionality for homes and commercial spaces.

Scan to know more about the product

Features

- Switches tested for up to 1 lakh on/off operations along with safety shuttered sockets
- Enhances décor with electronics, hospitality solutions and fast USB charging options (Type C 20W PD)
- High grade flame retardant polycarbonate material with laser etched markings
- Ranges tested for best-in-class quality with ISI, CRS & RoHS certification

Benefits

- Delivers long term value through high cycle durability testing
- Stylish design enhancing living spaces aesthetically
- Modular design offering flexibility & durability
- Assured quality with safety compliance and dependable performance



Shynora

Mechanisms White

Switches: • Polycarbonate Material • LED Based Indicator • Shrouded Terminal • ISI Marked



Switches 6A 230 V AC

HSN Code: 8536

			Cat. Nos.	Description	Module	MRP ₹ / Unit	Pack
 810600  810604  810605	810600	6A 1 way Switch	1	48	1/20/400		
	810610	6A 2 way Switch	1	100	1/20/200		
	810602	6A 1 way Switch with Indicator	1	102	1/20/200		
	810604	6A 1 way Switch with "Light" Marking	1	102	1/20/200		
	810605	6A 1 way Switch with "Fan" Marking	1	102	1/20/200		



Switches 10A 230 V AC

HSN Code: 8536

			Cat. Nos.	Description	Module	MRP ₹ / Unit	Pack
 810673  810674  810675	810673	10A 1 way Switch	1	54	1/20/200		
	810674	10A 2 way Switch	1	108	1/20/200		
	810675	10A 1 way Switch with Indicator	1	106	1/20/200		



Switches 16A 230 V AC

HSN Code: 8536

			Cat. Nos.	Description	Module	MRP ₹ / Unit	Pack
 810601  810611	810601	16A 1 way Switch	1	126	1/20/200		
	810611	16A 2 way Switch	1	172	1/10/100		
	810603	16A 1 way Switch with Indicator	1	154	1/20/200		

Switches 20A 230V AC

HSN Code: 8536

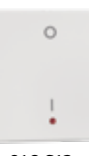
			Cat. Nos.	Description	Module	MRP ₹ / Unit	Pack
 810606  810607  810612	810606	20A 1 way Switch	1	170	1/20/200		
	810607	20A 1 way Switch with Indicator	1	196	1/20/200		
	810609	20A SP 1 way Switch	2	244	1/10/100		
	810612	20A DP switch with Indicator	2	220	1/10/100		

Switches 25A 230 V AC

HSN Code: 8536

			Cat. Nos.	Description	Module	MRP ₹ / Unit	Pack
 810608	810608	25A 1 way Switch with Indicator	1	230	1/20/200		

Switches 32A 230 V AC

HSN Code: 8536

			Cat. Nos.	Description	Module	MRP ₹ / Unit	Pack
 810613	810613	32A DP switch with indicator	2	304	1/10/100		

Shynora

Bell Push Button 6A 230 V AC

HSN Code: 8536



Cat. Nos.	Description	Module	MRP ₹ / Unit	Pack
810615	6A Bell Push Switch	1	108	1/20/200
810616	6A Bell Push Switch with Indicator	1	112	1/20/200
810617	6A Bell Push Switch with Indicator	2	174	1/10/100

Accessories for Switches

HSN Code: 8536



Cat. Nos.	Description	Module	MRP ₹ / Unit	Pack
810650	LED Indicator for switch	-	44	1/5/25

Indian Standard Sockets 240 V AC

HSN Code: 8536

Sockets: • Child Safety Shutter • Shrouded Terminals • Smooth Plug Removal & Insertion



Cat. Nos.	Description	Module	MRP ₹ / Unit	Pack
810620	6A 3 pin Round Socket with shutter (ISI mark)	2	132	1/20/200
810621	6A/16A 3 pin socket with shutter (ISI Mark)	2	250	1/10/100

Dimmers and Fan Regulators • Laser Marking

HSN Code: 8538 & 8414



Cat. Nos.	Description	Module	MRP ₹ / Unit	Pack
810641	Light Dimmer - 400W	1	482	1/10/100
810642	Light Dimmer - 500W	2	620	1/10/100
810638	Fan 4 Step Regulator 100W (ISI mark)	1	458	1/10/100
810639	Fan Step Regulator 360 deg 100W (ISI mark)	2	594	1/10/100
810640	Fan 8 step Regulator 100W (ISI mark)	2	696	1/10/100

Skirting Light

HSN Code: 9405



Cat. Nos.	Description	Module	MRP ₹ / Unit	Pack
810649	Skirting Light	2	464	1/5/50

Indicator

HSN Code: 8536



Cat. Nos.	Description	Module	MRP ₹ / Unit	Pack
810645	Flat Indicator Red	1	140	1/20/200

Shynora

Bell Call Indicator

HSN Code: 8536

	Cat. Nos.	Description	Module	MRP ₹ / Unit	Pack
 810644	810644	Bell Call Indicator	1	794	1/20/100

Buzzer



HSN Code: 8536

	Cat. Nos.	Description	Module	MRP ₹ / Unit	Pack
 810637	810637	Buzzer - 230V	1	338	1/20/100

Hospitality Function



Hotel Keycard Switch

HSN Code: 8538

	Cat. Nos.	Description	Module	MRP ₹ / Unit	Pack
 810614	810614	32A DP Keytag Switch (Mechanical)	2	542	1/10
 810646	810678	Keytag for (810614)		258	1/10/100
	810646	Key Card SW 15A + KEY FOB	2	2,790	1/10

Hotel "DND and MMR" Functions

HSN Code: 8538

	Cat. Nos.	Description	Module	MRP ₹ / Unit	Pack
 810647	810647	DND Internal Unit	2	364	1/10/100
 810648	810648	DND External Unit	2	432	1/10/100

Shaver Socket

HSN Code: 8538

	Cat. Nos.	Description	Module	MRP ₹ / Unit	Pack
 810666	810666	Shaver Socket	4	4918	1/5/20

Sockets and Connectors



TV Socket

HSN Code: 8536

	Cat. Nos.	Description	Module	MRP ₹ / Unit	Pack
 810633	810633	TV Socket	1	126	1/20/200

Data & Voice

HSN Code: 8536

	Cat. Nos.	Description	Module	MRP ₹ / Unit	Pack
 810631	810631	Telephone Socket - RJ11 with shutter	1	124	1/20/200
 810632	810632	Computer Socket - RJ45 Cat 6 with shutter	1	706	1/20/200

Shynora

Sound (Electronic Bell)

HSN Code: 8536

Cat. Nos.	Description	Module	MRP ₹ / Unit	Pack
810643	Electronic Bell	2	376	1/10/100



Protectors and Accessories

Motor Starter

HSN Code: 8536

Cat. Nos.	Description	Module	MRP ₹ / Unit	Pack
810664	16A MOTOR STARTER	2	644	10/50
810665	25A MOTOR STARTER	2	644	10/50



Modular MCB (IS : 608981:2002) • ISI Mark

HSN Code: 8536

Cat. Nos.	Description	Module	MRP ₹ / Unit	Pack
810654	6A MINI MCB SP C CURVE	1	488	1/1/100
810655	10A MINI MCB SP C CURVE	1	488	1/1/100
810656	16A MINI MCB SP C CURVE	1	488	1/1/100
810657	20A MINI MCB SP C CURVE	1	488	1/1/100
810658	25A MINI MCB SP C CURVE	1	488	1/1/100
810659	32A MINI MCB SP C CURVE	1	488	1/1/100
810660	16A MINI MCB DP C CURVE	2	866	1/1/100
810661	20A MINI MCB DP C CURVE	2	866	1/1/100
810662	25A MINI MCB DP C CURVE	2	866	1/1/100
810663	32A MINI MCB DP C CURVE	2	866	1/1/100



Power Unit

HSN Code: 8536

Cat. Nos.	Description	Module	MRP ₹ / Unit	Pack
810625	Power Unit Wth 20A MCB & 16A Plug	3	1,162	1/10
810626	Power Unit Wth 25A MCB & 16A Plug	3	1,246	1/10



Effortless charging, simplified living



Scan to know more
about the product

Shynora USB Chargers deliver fast, safe charging with new Type C PD (20W) along with Type A+C options with CRS certified and RoHS compliant.

Features

- Type C PD 20W fast charging along with Type A+C(15W) charging option
- CRS certified with RoHS compliance
- Dual port option Type A+C(15W) and Type A+A(15W) USB charging option

Benefits

- Reduces cable clutter with versatile Type A/C/A+C port options
- Ensures fast charging to maintain continuous operation
- Matches Shynora aesthetics in white/cool grey mechanisms

Shynora

Electronic Function

USB Chargers (IS13252 (Part 1) / IEC 60950-1) • CRS Certified

HSN Code: 8536

	Cat. Nos.	Description	Module	MRP ₹ / Unit	Pack
	810652	USB Charger 1500mA Type A	1	1,084	1/10/100
	810651	Double USB charger 3000mA Type A+A	2	1,736	1/10/100
	810676	USB Charger Type C 20W PD	1	2,940	1/10/100
	810677	USB Charger 3000mA, 15W Type A+C	1	2,214	1/10/100
	810669	Double USB Charger 3000mA, 15W Type A+C	2	1,972	1/10/100

Accessories

HSN Code: 8538

	Cat. Nos.	Description	Module	MRP ₹ / Unit	Pack
	810667	1 Module Blank Plate	1	32	1/40/400
	810668	Cable Outlet	1	100	1/20/100

Cool Grey Mechanisms

Switches: • Polycarbonate Material • LED Based Indicator • Shrouded Terminal • ISI Marked

Switches 6A 230 V AC

HSN Code: 8536

	Cat. Nos.	Description	Module	MRP ₹ / Unit	Pack
	810700	6A 1 way Switch	1	56	1/20/400
	810710	6A 2 way Switch	1	116	1/20/200
	810702	6A 1 way Switch with Indicator	1	110	1/20/200
	810704	6A 1 way Switch with "Light" Marking	1	122	1/20/200
	810705	6A 1 way Switch with "Fan" Marking	1	122	1/20/200

Switches 16A 230 V AC

HSN Code: 8536

	Cat. Nos.	Description	Module	MRP ₹ / Unit	Pack
	810701	16A 1 way Switch	1	154	1/20/200
	810711	16A 2 way Switch	1	208	1/10/100
	810703	16A 1 way Switch with Indicator	1	166	1/20/200

Switches 20A 230V AC

HSN Code: 8536

	Cat. Nos.	Description	Module	MRP ₹ / Unit	Pack
	810706	20A 1 way Switch	1	198	1/20/200
	810707	20A 1 way Switch with Indicator	1	228	1/20/200
	810709	20A SP1 way Switch	2	280	1/10/100
	810712	20A DP switch with Indicator	2	252	1/10/100

Shynora

Switches 25A 230 V AC

HSN Code: 8536

	Cat. Nos.	Description	Module	MRP ₹ / Unit	Pack
 810708	810708	25A 1 way Switch with Indicator	1	250	1/20/200



Switches 32A 230 V AC

HSN Code: 8536

	Cat. Nos.	Description	Module	MRP ₹ / Unit	Pack
 810713	810713	32A DP switch with indicator	2	350	1/10/100

Bell Push Button 6A 230 V AC



HSN Code: 8536

	Cat. Nos.	Description	Module	MRP ₹ / Unit	Pack
	810715	6A Bell Push Switch	1	126	1/20/200
	810716	6A Bell Push Switch with Indicator	1	138	1/20/200
	810717	6A Bell Push Switch with Indicator	2	202	1/10/100

Indian Standard Sockets 240 V AC

HSN Code: 8536

Sockets: • Child Safety Shutter • Shrouded Terminals • Smooth Plug Removal & Insertion

	Cat. Nos.	Description	Module	MRP ₹ / Unit	Pack
 810720	810720	6A 3 pin Round Socket with shutter (ISI mark)	2	156	1/20/200
 810721	810721	6A/16A 3 pin socket with shutter (ISI Mark)	2	288	1/10/100

Dimmers & Fan Regulators • Laser Marking

HSN Code: 8538 & 8414

	Cat. Nos.	Description	Module	MRP ₹ / Unit	Pack
	810741	Light Dimmer - 400W	1	552	1/10/100
	810742	Light Dimmer - 500W	2	726	1/10/100
	810738	Fan Step Regulator 100W (ISI mark)	1	528	1/10/100
	810739	Fan Step Regulator 360 deg 100W (ISI mark)	2	696	1/10/100
	810740	Fan 8 step Regulator 100W (ISI mark)	2	840	1/10/100

Skirting Light

HSN Code: 9405

	Cat. Nos.	Description	Module	MRP ₹ / Unit	Pack
 810749	810749	Skirting Light	2	506	1/5/50

Shynora

Indicator

HSN Code: 8536



810745

Cat. Nos.	Description	Module	MRP ₹ / Unit	Pack
810745	Flat Indicator Red	1	150	1/20/200

Buzzer

HSN Code: 8536



810737

Cat. Nos.	Description	Module	MRP ₹ / Unit	Pack
810737	Buzzer - 230V	1	390	1/20/100

Hospitality Function

Hotel Keycard Switch

HSN Code: 8538



810714



810746

Cat. Nos.	Description	Module	MRP ₹ / Unit	Pack
810714	32A DP Keytag Switch (Mechanical)	2	624	1/10
810778	Keytag for (810714)		298	1/10/100
810746	Key Card SW 15A + KEY FOB	2	3,568	1/10

Hotel "DND and MMR" Functions

HSN Code: 8538



810747



810748

Cat. Nos.	Description	Module	MRP ₹ / Unit	Pack
810747	DND Internal Unit	2	448	1/10/100
810748	DND External Unit	2	508	1/10/100

Shaver Socket

HSN Code: 8538



810766

Cat. Nos.	Description	Module	MRP ₹ / Unit	Pack
810766	Shaver Socket	4	6,094	1/5/20

Sockets and Connectors

TV Socket

HSN Code: 8536



810733

Cat. Nos.	Description	Module	MRP ₹ / Unit	Pack
810733	TV Socket	1	146	1/20/200

Shynora

Data & Voice

HSN Code: 8536



810731

Cat. Nos.	Description	Module	MRP ₹ / Unit	Pack
810731	Telephone Socket - RJ11 with shutter	1	144	1/20/200
810732	Computer Socket - RJ45 Cat 6 with shutter	1	820	1/20/200

Protectors and Accessories

Motor Starter

HSN Code: 8536



810764



810765

Cat. Nos.	Description	Module	MRP ₹ / Unit	Pack
810764	16A Motor Starter	2	758	10/50
810765	25A Motor Starter	2	758	10/50

Modular MCB (IS : 608981:2002) • ISI Mark

HSN Code: 8536



810754



810757



810758

Cat. Nos.	Description	Module	MRP ₹ / Unit	Pack
810754	6A Mini MCB SP C Curve	1	564	1/1/100
810755	10A Mini MCB SP C Curve	1	564	1/1/100
810756	16A Mini MCB SP C Curve	1	564	1/1/100
810757	20A Mini MCB SP C Curve	1	564	1/1/100
810758	25A Mini MCB SP C Curve	1	564	1/1/100
810759	32A Mini MCB SP C Curve	1	564	1/1/100

Power Unit

HSN Code: 8536



810725

Cat. Nos.	Description	Module	MRP ₹ / Unit	Pack
810725	Power Unit with 20A MCB & 16A Plug	3	1,354	1/10
810726	Power Unit with 25A MCB & 16A Plug	3	1,454	1/10

Electronic Function

USB Chargers (IS13252 (Part 1) / IEC 60950-1) • CRS Certified

HSN Code: 8536



810752



810751



810769

Cat. Nos.	Description	Module	MRP ₹ / Unit	Pack
810752	USB Charger 1500mA Type A	1	1,354	1/10/100
810751	Double USB charger 3000mA Type A+A	2	2,004	1/10/100
810776	USB Charger Type C 20W PD	1	3,318	1/10/100
810777	USB Charger 3000mA, 15W Type A+C	1	2,398	1/10/100
810769	Double USB Charger 3000mA, 15W Type A+C	2	2,246	1/10/100

Shynora

Accessories

HSN Code: 8538

Cat. Nos.	Description	Module	MRP ₹ / Unit	Pack
810767	1 Module Blank Plate	1	38	1/40/400
810768	Cable Outlet	1	108	1/20/100



Shynora Plate Frame White

HSN Code: 8538

Plate & Frame • Strong Dimensional Stability

Cat. Nos.	Description	Module	MRP ₹ / Unit	Pack
810800	White Plate + Frame, 1 module	1	102	1/10/100
810801	White Plate + Frame, 2 module	2	102	1/10/100
810802	White Plate + Frame, 3 module	3	152	1/10/100
810803	White Plate + Frame, 4 module	4	162	1/10/100
810804	White Plate + Frame, 6 module	6	224	1/10/100
810805	White Plate + Frame, 8 module	8	288	1/10/100
810806	White Plate + Frame, 2X4 module	8	288	1/5/25
810807	White Plate + Frame, 9 module	9	322	1/5/50
810808	White Plate + Frame, 12 module	12	380	1/5/25
810809	White Plate + Frame, 16 module	16	434	1/5/25
810810	White Plate + Frame, 18 module	18	508	1/5/25



810800



810801



810805



810810

Shynora Plate Frame Cool Grey

HSN Code: 8538

Cat. Nos.	Description	Module	MRP ₹ / Unit	Pack
810811	Cool Grey Plate + Frame, 1 module	1	126	1/10/100
810812	Cool Grey Plate + Frame, 2 module	2	126	1/10/100
810813	Cool Grey Plate + Frame, 3 module	3	184	1/10/100
810814	Cool Grey Plate + Frame, 4 module	4	198	1/10/100
810815	Cool Grey Plate + Frame, 6 module	6	278	1/10/100
810816	Cool Grey Plate + Frame, 8 module	8	320	1/10/100
810817	Cool Grey Plate + Frame, 2X4 module	8	320	1/5/25
810818	Cool Grey Plate + Frame, 9 module	9	394	1/5/50
810819	Cool Grey Plate + Frame, 12 module	12	462	1/5/25
810820	Cool Grey Plate + Frame, 16 module	16	520	1/5/25
810821	Cool Grey Plate + Frame, 18 module	18	626	1/5/25



810811



810812



810814



810816

Shynora Plate Frame Chrome

HSN Code: 8538

Cat. Nos.	Description	Module	MRP ₹ / Unit	Pack
810833	Chrome Plate + Frame, 1 module	1	114	1/10/100
810834	Chrome Plate + Frame, 2 module	2	114	1/10/100



810833

Shynora

Shynora Plate Frame Chrome

HSN Code: 8538

	Cat. Nos.	Description	Module	MRP ₹ / Unit	Pack
	810835	Chrome Plate + Frame, 3 module	3	160	1/10/100
	810836	Chrome Plate + Frame, 4 module	4	186	1/10/100
	810837	Chrome Plate + Frame, 6 module	6	260	1/10/100
	810838	Chrome Plate + Frame, 8 module	8	302	1/10/100
	810839	Chrome Plate + Frame, 2X4 module	8	302	1/5/25
	810840	Chrome Plate + Frame, 9 module	9	374	1/5/50
	810841	Chrome Plate + Frame, 12 module	12	428	1/5/25
	810842	Chrome Plate + Frame, 16 module	16	494	1/5/25
	810843	Chrome Plate + Frame, 18 module	18	590	1/5/25

Shynora Plate Frame Pink

HSN Code: 8538

	Cat. Nos.	Description	Module	MRP ₹ / Unit	Pack
	810844	Pink Plate + Frame, 1 module	1	140	1/10/100
	810845	Pink Plate + Frame, 2 module	2	140	1/10/100
	810846	Pink Plate + Frame, 3 module	3	192	1/10/100
	810847	Pink Plate + Frame, 4 module	4	222	1/10/100
	810848	Pink Plate + Frame, 6 module	6	316	1/10/100
	810849	Pink Plate + Frame, 8 module	8	388	1/10/100
	810850	Pink Plate + Frame, 2X4 module	8	388	1/5/25
	810851	Pink Plate + Frame, 9 module	9	456	1/5/50
	810852	Pink Plate + Frame, 12 module	12	522	1/5/25
	810853	Pink Plate + Frame, 16 module	16	654	1/5/25
810854	Pink Plate + Frame, 18 module	18	712	1/5/25	

Shynora Plate Frame Milan Gold

HSN Code: 8538





	Cat. Nos.	Description	Module	MRP ₹ / Unit	Pack
	810855	Milan Gold Plate + Frame, 1 module	1	140	1/10/100
	810856	Milan Gold Plate + Frame, 2 module	2	140	1/10/100
	810857	Milan Gold Plate + Frame, 3 module	3	192	1/10/100
	810858	Milan Gold Plate + Frame, 4 module	4	222	1/10/100
	810859	Milan Gold Plate + Frame, 6 module	6	316	1/10/100
	810860	Milan Gold Plate + Frame, 8 module	8	388	1/10/100
	810861	Milan Gold Plate + Frame, 2X4 module	8	388	1/5/25
	810862	Milan Gold Plate + Frame, 9 module	9	456	1/5/50
	810863	Milan Gold Plate + Frame, 12 module	12	522	1/5/25
	810864	Milan Gold Plate + Frame, 16 module	16	654	1/5/25
810865	Milan Gold Plate + Frame, 18 module	18	712	1/5/25	

Shynora



Metal Flush Boxes • Made of G.I. Sheet • Earth Terminal for Safety • Provision for Knockouts Available

• ISI Marked

HSN Code: 8538

	Cat. Nos.	Description	Module	MRP ₹ / Unit	Pack
 800172	800172	Metal Flush Box, 1/2 Module	1/2	78	40
 800174	800173	Metal Flush Box, 3 Module	3	102	40
 810867	800174	Metal Flush Box, 4 Module	4	120	40
 800180	800176	Metal Flush Box, 6 Module	6	180	20
	800177	Metal Flush Box, 8 Module (vertical)	8	232	20
	800178	Metal Flush Box, 8 Module (horizontal)	8	232	20
	810867	Metal Flush Box, 9 Module	9	278	20
	800175	Metal Flush Box, 12 Module	12	304	10
	800179	Metal Flush Box, 16 Module	16	350	10
	800180	Metal Flush Box, 18 Module	18	382	10

Plastic Surface Boxes • Flame Retardant Material • Edge to Edge Fitting with Plate • ISI Marked HSN Code: 8538

	Cat. Nos.	Description	Module	MRP ₹ / Unit	Pack
 800182	800182	Plastic Surface Box, 1/2 Module	1/2	80	50
 800184	800183	Plastic Surface Box, 3 Module	3	102	35
	800184	Plastic Surface Box, 4 Module	4	116	25
	800186	Plastic Surface Box, 6 Module	6	176	10
 800187	800187	Plastic Surface Box, 8 Module (vertical)	8	240	15
 800185	810866	Plastic Surface Box, 8 Module (horizontal)	8	252	10
	800185	Plastic Surface Box, 12 Module	12	302	10
	800189	Plastic Surface Box, 16 Module	16	352	10
	800190	Metal Surface Box, 18 Module	18	392	10

Dimensions

Cover Plates-Shynora

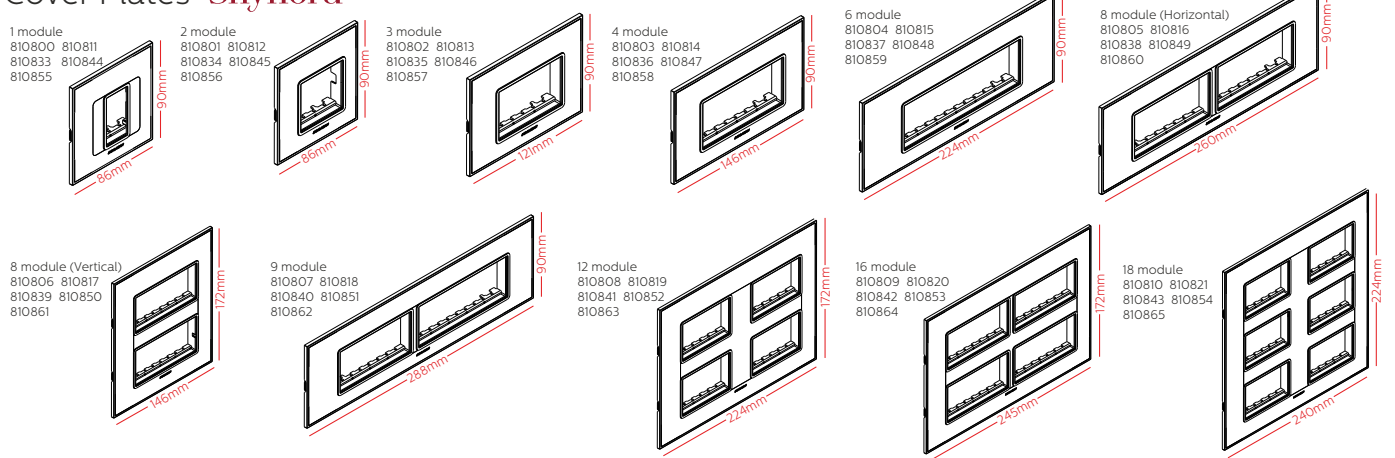

Flush Boxes-Metal

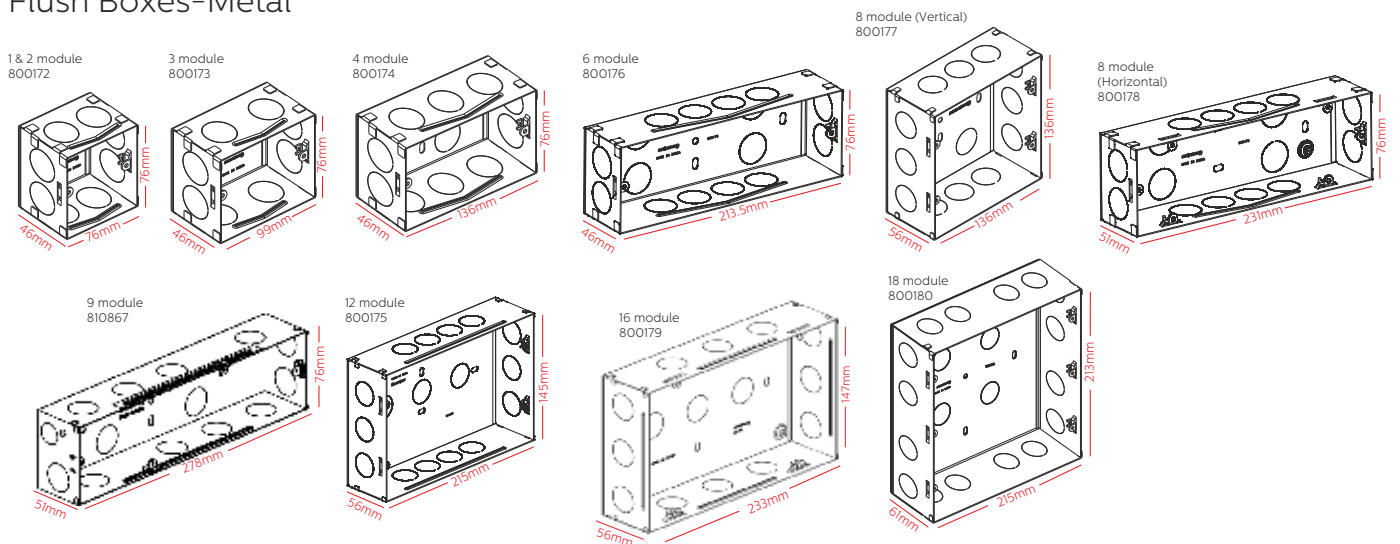

Surface Boxes-Plastic

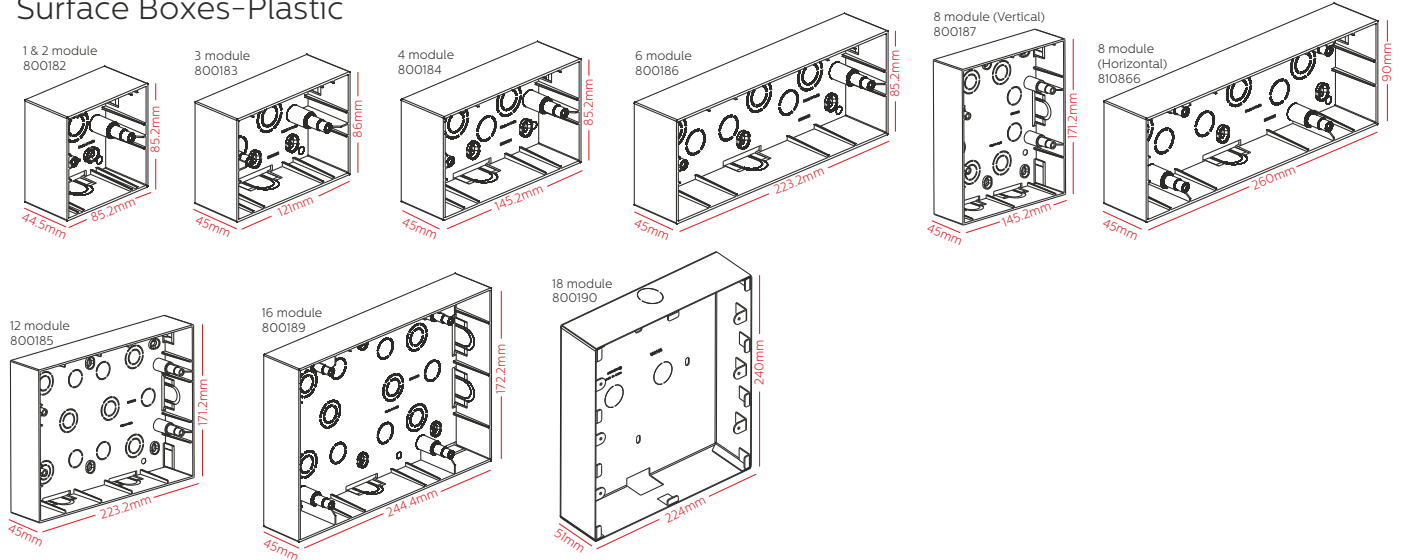

Elevate your space with refined elegance



Scan to know more about the product

Glint is a wiring device range designed to suit everyday interiors suitable for residential and commercial applications.

Features

- Switches tested for up to 1 lakh on/off operations along with safety shuttered sockets
- Modular design for quick assembly with heat resistant body for enhanced safety
- ISI and RoHS Certified

Benefits

- An economical modular system built for diverse applications
- Easy installation & low maintenance
- Ensures safe operation and long product life



Glint™

Mechanisms White

Switches: • Polycarbonate Material • LED Based Indicator • ISI Marked



Switches 6A 230 V AC

HSN Code: 8536

 		Cat. Nos.	Description	Module	MRP ₹ / Unit	Pack
800000	800001	800000	6A 1 way Switch	1	38	1/20/400
		800001	6A 2 way Switch	1	80	1/20/200

Switches 16A 230 V AC

HSN Code: 8536

  			Cat. Nos.	Description	Module	MRP ₹ / Unit	Pack
800002	800003	800004	800002	16A 1 way Switch	1	108	1/20/200
			800003	16A 2 way Switch	1	138	1/10/100
			800004	16A 1 way Switch with indicator	1	132	1/10/100

Switches 20A 230V AC

HSN Code: 8536

		Cat. Nos.	Description	Module	MRP ₹ / Unit	Pack
800005		800005	20A DP Switch with indicator	2	166	1/10/50

Switches 25A 230V AC

HSN Code: 8536

		Cat. Nos.	Description	Module	MRP ₹ / Unit	Pack
800089		800089	25A Switch with Indicator	1	142	1/10/100



Switches 32A 230 V AC

HSN Code: 8536

		Cat. Nos.	Description	Module	MRP ₹ / Unit	Pack
800006		800006	32A DP Switch with indicator	2	240	1/10/50

Bell Push Button 6A 230 V AC

HSN Code: 8536

 		Cat. Nos.	Description	Module	MRP ₹ / Unit	Pack
800007	800008	800007	6A Bell Push with Indicator	1	94	1/10/100
		800008	6A Bell Push with Indicator	2	140	1/10/100

Glint™

Mechanisms White

Sockets: • Child Safety Shutter • Smooth Plug Removal & Insertion

Indian Standard Sockets 240 V AC

HSN Code: 8536

	Cat. Nos.	Description	Module	MRP ₹ / Unit	Pack
 800022	801800	6A 3 pin Round Socket with shutter (ISI mark)	2	80	1/20/200
	800022	6A/16A 3 pin socket with shutter (ISI Mark)	2	152	1/10/100

Dimmers and Fan Regulators •Laser Marking for Easy Identification

HSN Code: 8538 & 8414

	Cat. Nos.	Description	Module	MRP ₹ / Unit	Pack
 800042 800043	800042	Light Dimmer -400W	1	390	1/10/100
	800041	Fan 4 Step Regulator -100W	1	400	1/10/100
	800043	Fan 4 Step Regulator -100W	2	450	1/10/100
	800090	Fan 5 Step Regulator -100W (ISI mark)	2	398	1/10/100
	800091	Fan 8 Step Regulator -100W (ISI mark)	2	398	1/10/100

Skirting Light

HSN Code: 8536

	Cat. Nos.	Description	Module	MRP ₹ / Unit	Pack
 800092	800092	Skirting Light	2	296	1/5/25

Indicator

HSN Code: 8536

	Cat. Nos.	Description	Module	MRP ₹ / Unit	Pack
 800033	800033	Flat Indicator Red	1	116	1/10/100

Buzzer

HSN Code: 8536

	Cat. Nos.	Description	Module	MRP ₹ / Unit	Pack
 800040	800040	Buzzer - 230V	1	224	1/20/100

Hospitality Function

Hotel Keycard Switch

HSN Code: 8536

	Cat. Nos.	Description	Module	MRP ₹ / Unit	Pack
 800093	800093	32A DP Keytag Switch (Mechanical)	2	392	1/10

Glint™

Hotel “DND and MMR” Functions

HSN Code: 8536

	Cat. Nos.	Description	Module	MRP ₹ / Unit	Pack
 800094	800094	DND Internal Unit	2	144	1/10/100
	800095	DND External Unit	2	260	1/10/100

Sockets and Connectors

TV Socket

HSN Code: 8536

	Cat. Nos.	Description	Module	MRP ₹ / Unit	Pack
 800032	800032	TV Socket	1	80	1/20/100

Data & Voice

HSN Code: 8536

	Cat. Nos.	Description	Module	MRP ₹ / Unit	Pack
 800030	800030	Telephone Socket - RJ11	1	88	1/20/100
	800031	Computer Socket- RJ45 Cat 6	1	200	1/20/100

Protectors and Accessories

Modular MCB (IS : 608981:2002) • Laser Marking

HSN Code: 8536

	Cat. Nos.	Description	Module	MRP ₹ / Unit	Pack
 800097	800097	6A MINI MCB SP C CURVE	1	252	1/10/100
	800098	10A MINI MCB SP C CURVE	1	252	1/10/100
	800010	16A MINI MCB SP C CURVE	1	380	1/10/100
	800011	20A MINI MCB SP C CURVE	1	380	1/10/100
	800012	25A MINI MCB SP C CURVE	1	380	1/10/100
	800013	32A MINI MCB SP C CURVE	1	380	1/10/100

Motor Starter

HSN Code: 8536

	Cat. Nos.	Description	Module	MRP ₹ / Unit	Pack
 800096	800096	25A MOTOR STARTER	2	414	1/10/50

Electronic Function

USB Chargers (IS13252 (Part 1) / IEC 60950-1) • CRS Certified

HSN Code: 8536

	Cat. Nos.	Description	Module	MRP ₹ / Unit	Pack
 800044	800044	USB Charger 1500mA Type A	1	942	1/10/100

Glint™

Accessories • Spare Screw Caps

HSN Code: 8538

Cat. Nos.	Description	Module	MRP ₹ / Unit	Pack
800051	1 Module Blank Plate	1	28	1/20/200
800052	2 Module Blank Plate	2	32	1/10/100
800059	Screw Caps	0	28	1/10/100

Plate & Frame: • Unique Design - Sleek & Curvy • Flame Retardant Material • Compatible with Standard Size of Metal Flush & Plastic Surface Boxes

Glint Single Plates White

HSN Code: 8538

Cat. Nos.	Description	Module	MRP ₹ / Unit	Pack
800061	1 Module Plate	1	62	1/10/100
800062	2 Module Plate	2	62	1/10/100
800063	3 Module Plate	3	88	1/10/100
800064	4 Module Plate	4	104	1/10/100
800066	6 Module Plate	6	130	1/5/50
800067	8 Module Plate (Vertical)	8	182	1/5/25
800068	8 Module Plate (Horizontal)	8	172	1/5/50
800065	12 Module Plate	12	238	1/5/25
800069	16 Module Plate	16	248	1/5/25
800070	18 Module Plate	18	302	1/5/25

Glint Double Plates: • Aesthetic Design • Suitable for Metal Flush & Wooden Boxes • Comes with Regular & Self Tapping Screws

Plate & Frame

HSN Code: 8538

Cat. Nos.	Description	Module	MRP ₹ / Unit	Pack
800071	White Plate + Frame, 1M	1	92	1/10/100
800072	White Plate + Frame, 2M	2	92	1/10/100
800073	White Plate + Frame, 3M	3	118	1/10/100
800074	White Plate + Frame, 4M	4	150	1/10/100
800076	White Plate + Frame, 6M	6	188	1/10/50
800078	White Plate + Frame, 8M (Vertical)	8	268	1/5/25
800079	White Plate + Frame, 8M (Horizontal)	8	268	1/10/50
800080	White Plate + Frame, 10M	10	318	1/5/25
800082	White Plate + Frame, 12M (Vertical)	12	346	1/5/25
800084	White Plate + Frame, 12M (Horizontal)	12	346	1/5/25
800086	White Plate + Frame, 16M	16	392	1/5/25
800088	White Plate + Frame, 18M	18	426	1/5/25

Glint™

Metal Flush Boxes

HSN Code: 8538



Cat. Nos.	Description	Module	MRP ₹ / Unit	Pack
800172	Metal Flush Box, 1/2 Module	1/2	78	40
800173	Metal Flush Box, 3 Module	3	102	40
800174	Metal Flush Box, 4 Module	4	120	40
800176	Metal Flush Box, 6 Module	6	180	20
800177	Metal Flush Box, 8 Module (vertical)	8	232	20
800178	Metal Flush Box, 8 Module (horizontal)	8	232	20
810867	Metal Flush Box, 9 Module	9	278	20
800175	Metal Flush Box, 12 Module	12	304	10
800179	Metal Flush Box, 16 Module	16	350	10
800180	Metal Flush Box, 18 Module	18	382	10

Plastic Surface Boxes

HSN Code: 8538



Cat. Nos.	Description	Module	MRP ₹ / Unit	Pack
800182	Plastic Surface Box, 1/2 Module	1/2	80	50
800183	Plastic Surface Box, 3 Module	3	102	35
800184	Plastic Surface Box, 4 Module	4	116	25
800186	Plastic Surface Box, 6 Module	6	176	10
800187	Plastic Surface Box, 8 Module (vertical)	8	240	15
800188	Plastic Surface Box 8 Module (horizontal)	8	240	10
800185	Plastic Surface Box, 12 Module	12	302	10
800189	Plastic Surface Box, 16 Module	16	352	10
800190	Metal Surface Box, 18 Module	18	392	10

Dimensions

Cover Plates-Glint™

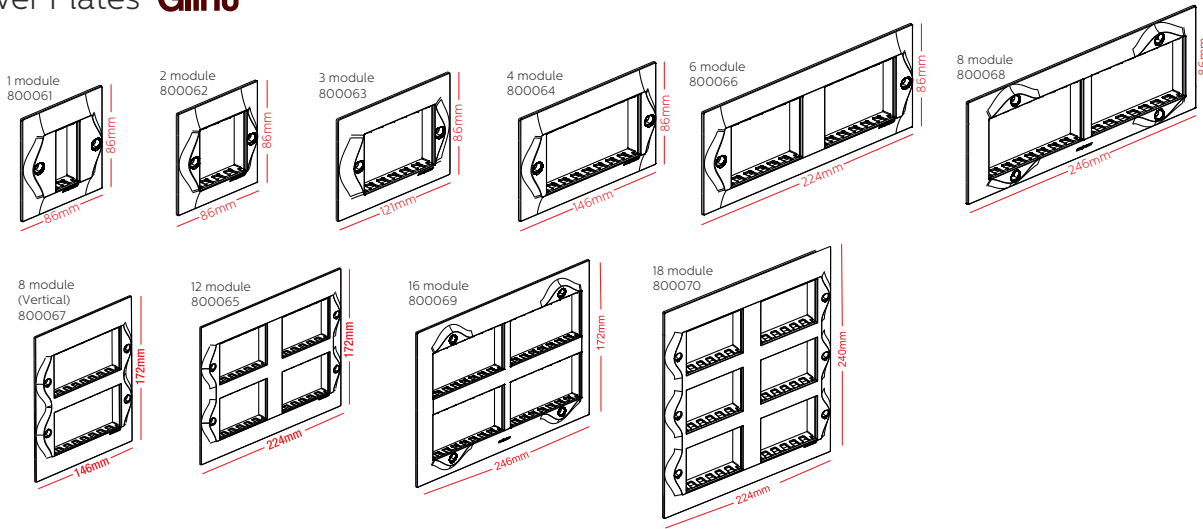

Flush Boxes-Metal

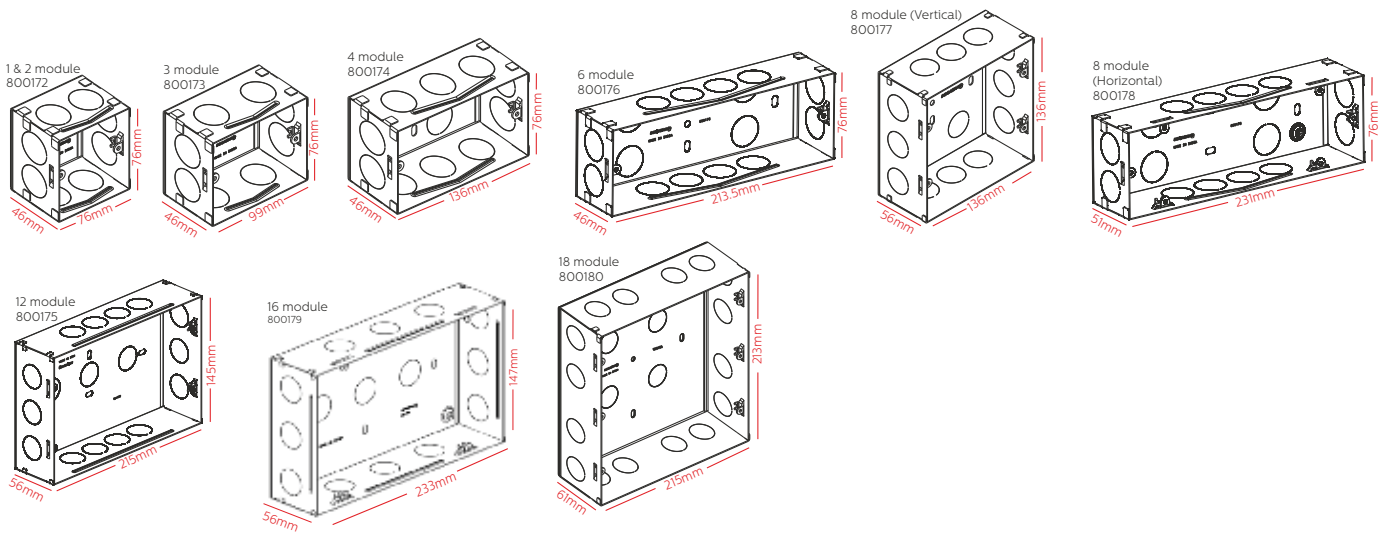

Surface Boxes-Plastic

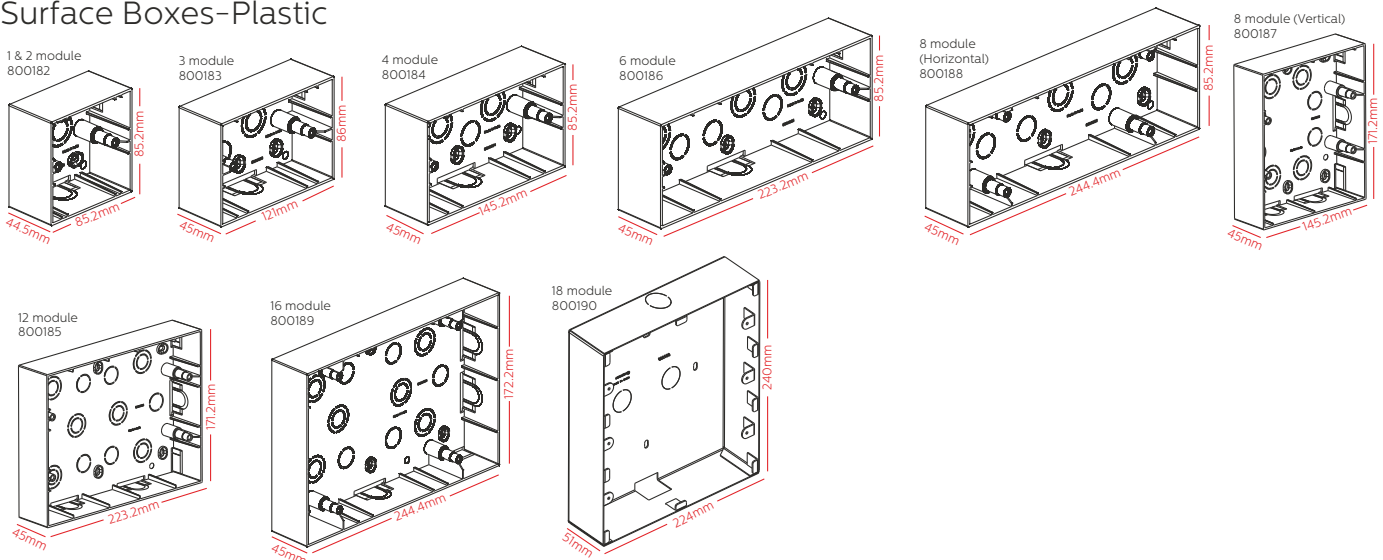

We think better,
you live better



Elvira is a modular range designed for modern residential and commercial spaces. It combines sleek design and durable performance, with ISI certified products.

Scan to know more
about the product

Features

- Switches tested for up to 1 lakh on/off operations along with safety shuttered sockets
- Simple design enabling quick & easy installation
- Flame retardant plastic material used for end user safety
- ISI certified switches and sockets compliant with RoHS & BIS standards

Benefits

- Designed for long-term reliability with safety
- Balances modern aesthetics with safe operation
- Tested for electrical, mechanical, and thermal strength



ELVIRA

White Mechanisms

Switches: • Polycarbonate Material • LED Based Indicator • ISI Marked



Switches 6A 230 V AC

HSN Code: 8536

		Cat. Nos.	Description	Module	MRP ₹ / Unit	Pack
 800100  800101		800100	6A 1 way Switch	1	42	1/20/400
		800101	6A 2 way Switch	1	98	1/20/100
		800102	6A 1 way Switch with Indicator	1	96	1/20/200



Switches 10A 230 V AC

HSN Code: 8536

		Cat. Nos.	Description	Module	MRP ₹ / Unit	Pack
 800114  800115  800116		800114	10A 1 way Switch	1	46	1/20/400
		800115	10A 2 way Switch	1	102	1/20/100
		800116	10A 1 way Switch with Indicator	1	100	1/20/200

Switches 16A 230 V AC

HSN Code: 8536

		Cat. Nos.	Description	Module	MRP ₹ / Unit	Pack
 800103  800104  800105		800103	16A 1 way Switch	1	124	1/20/200
		800104	16A 2 way Switch	1	168	1/10/100
		800105	16A 1 way Switch with Indicator	1	146	1/20/200

Switches 20A 230V AC

HSN Code: 8536

		Cat. Nos.	Description	Module	MRP ₹ / Unit	Pack
 800107		800107	20A DP Switch with indicator	2	214	1/10/50

Switches 25A 230 V AC

HSN Code: 8536

		Cat. Nos.	Description	Module	MRP ₹ / Unit	Pack
 800106		800106	25A 1 way Switch with Indicator	1	222	1/10/100

Switches 32A 230 V AC

HSN Code: 8536

		Cat. Nos.	Description	Module	MRP ₹ / Unit	Pack
 800108		800108	32A DP Switch with indicator	2	296	1/10/50

ELVIRA

Bell Push Button 6A 230 V AC

HSN Code: 8536

Cat. Nos.	Description	Module	MRP ₹ / Unit	Pack
800110	6A Bell Push with Indicator	1	110	1/20/200
800111	6A Bell Push with Indicator	2	172	1/10/100



Indian Standard Sockets 240 V AC:

HSN Code: 8536

Sockets • Child Safety Shutter • Smooth Plug Removal & Insertion

Cat. Nos.	Description	Module	MRP ₹ / Unit	Pack
802800	6A 3 pin Round Socket with Shutter (ISI Mark)	2	104	1/20/200
800122	6A/16A 3 Pin Socket with Shutter (ISI Mark)	2	206	1/10/50

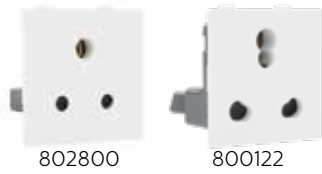

Dimmers and Fan Regulators: • Laser Marking for Easy Identification

HSN Code: 8538 & 8414

Cat. Nos.	Description	Module	MRP ₹ / Unit	Pack
800143	Light Dimmer 400W	1	466	1/10/100
800141	Fan 4 Step Regulator 100W (ISI Mark)	1	442	1/10/100
800142	Fan 4 step Regulator 100W (ISI Mark)	2	548	1/10/100
800139	Fan 8 step Regulator 100W (ISI Mark)	2	674	1/10/100



Skirting Light

HSN Code: 8536

Cat. Nos.	Description	Module	MRP ₹ / Unit	Pack
800155	Skirting Light	2	450	1/5/25



Indicator

HSN Code: 8536

Cat. Nos.	Description	Module	MRP ₹ / Unit	Pack
800154	Flat Indicator Red	1	132	1/20/100



Buzzer

HSN Code: 8536

Cat. Nos.	Description	Module	MRP ₹ / Unit	Pack
800140	Buzzer - 230V	1	334	1/20/100



Bell Call Indicator

HSN Code: 8536

Cat. Nos.	Description	Module	MRP ₹ / Unit	Pack
800144	Bell Call Indicator	1	712	1/20/100



ELVIRA

Sockets and Connectors



TV Socket

HSN Code: 8536

		Cat. Nos.	Description	Module	MRP ₹ / Unit	Pack
 800132		800132	TV Socket	1	114	1/20/100

Data & Voice

HSN Code: 8536

		Cat. Nos.	Description	Module	MRP ₹ / Unit	Pack
 800130		800130	Telephone Socket - RJ11	1	118	1/20/100
 800131		800131	Computer Socket- RJ45 Cat 6	1	292	1/20/100

Protectors and Accessories

Motor Starter



HSN Code: 8536

		Cat. Nos.	Description	Module	MRP ₹ / Unit	Pack
 800196		800196	25A Motor Starter	2	544	1/10/50

MCB: (IS : 608981:2002) • Laser Marking

Modular MCB

HSN Code: 8536

		Cat. Nos.	Description	Module	MRP ₹ / Unit	Pack
 800160		800160	16A MINI MCB SP C CURVE	1	484	1/10/100
 800156		800191	20A MINI MCB SP C CURVE	1	484	1/10/100
		800156	25A MINI MCB SP C CURVE	1	484	1/10/100
		800157	32A MINI MCB SP C CURVE	1	484	1/10/100

Power Unit

HSN Code: 8536

		Cat. Nos.	Description	Module	MRP ₹ / Unit	Pack
 800193		800193	Power Unit with 20A MCB & 16A PLUG	3	1,142	1/10
		800194	Power Unit with 25A MCB & 16A PLUG	3	1,226	1/10

Electronic Function (IS13252 (Part 1) / IEC 60950-1) • CRS Certified

USB Chargers

HSN Code: 8536

		Cat. Nos.	Description	Module	MRP ₹ / Unit	Pack
 800145		800145	USB charger 1500mA Type A	1	1,066	1/10/100

ELVIRA

Hospitality Function

Hotel Keycard Switch

HSN Code: 8538

	Cat. Nos.	Description	Module	MRP ₹ / Unit	Pack
 800197	800197	Key card Switch 15A	2	2,722	1/1/10

Hotel "DND and MMR" Functions

HSN Code: 8538

	Cat. Nos.	Description	Module	MRP ₹ / Unit	Pack
 800192	800192	DND INTERNAL UNIT	2	234	1/10/100
	800195	DND EXTERNAL UNIT	2	278	1/10/100

Accessories

HSN Code: 8538







	Cat. Nos.	Description	Module	MRP ₹ / Unit	Pack
 800151	800151	1 Module Blank Plate	1	30	1/20/200
 800153	800152	2 Module Blank plate	2	56	1/10/100
	800153	Cable Outlet	1	94	1/20/100

Plate & Frame: • Strong Dimensional Stability

Elvira Double Plates White



HSN Code: 8538

	Cat. Nos.	Description	Module	MRP ₹ / Unit	Pack
 800161	800161	White Plate + Frame, 1M	1	98	1/10/100
	800162	White Plate + Frame, 2M	2	98	1/10/100
 800163	800163	White Plate + Frame, 3M	3	136	1/10/100
	800164	White Plate + Frame, 4M	4	156	1/10/100
 800166	800166	White Plate + Frame, 6M	6	202	1/10/100
	800167	White Plate + Frame, 8M (Vertical)	8	280	1/5/25
	800168	White Plate + Frame, 8M (Horizontal)	8	278	1/10/100
 800170	800165	White Plate + Frame, 12M	12	374	1/5/25
	800169	White Plate + Frame, 16M	16	414	1/5/25
	800170	White Plate + Frame, 18M	18	500	1/5/25

ELVIRA



Metal Flush Boxes

HSN Code: 8538

		Cat. Nos.	Description	Module	MRP ₹ / Unit	Pack
		800172	Metal Flush Box, 1/2 Module	1/2	78	40
		800173	Metal Flush Box, 3 Module	3	102	40
		800174	Metal Flush Box, 4 Module	4	120	40
		800176	Metal Flush Box, 6 Module	6	180	20
		800177	Metal Flush Box, 8 Module (vertical)	8	232	20
		800178	Metal Flush Box, 8 Module	8	232	20
		810867	Metal Flush Box, 9 Module	9	278	20
		800175	Metal Flush Box, 12 Module	12	304	10
		800179	Metal Flush Box, 16 Module	16	350	10
		800180	Metal Flush Box, 18 Module	18	382	10

Plastic Surface Boxes

HSN Code: 8538

		Cat. Nos.	Description	Module	MRP ₹ / Unit	Pack
		800182	Plastic Surface Box, 1/2 Module	1/2	80	50
		800183	Plastic Surface Box, 3 Module	3	102	35
		800184	Plastic Surface Box, 4 Module	4	116	25
		800186	Plastic Surface Box, 6 Module	6	176	10
		800187	Plastic Surface Box, 8 Module (vertical)	8	240	15
		800188	Plastic Surface Box 8 Module	8	240	10
		800185	Plastic Surface Box, 12 Module	12	302	10
		800189	Plastic Surface Box, 16 Module	16	352	10
		800190	Metal Surface Box, 18 Module	18	392	10

Dimensions

Cover Plates-**ELVIRA**

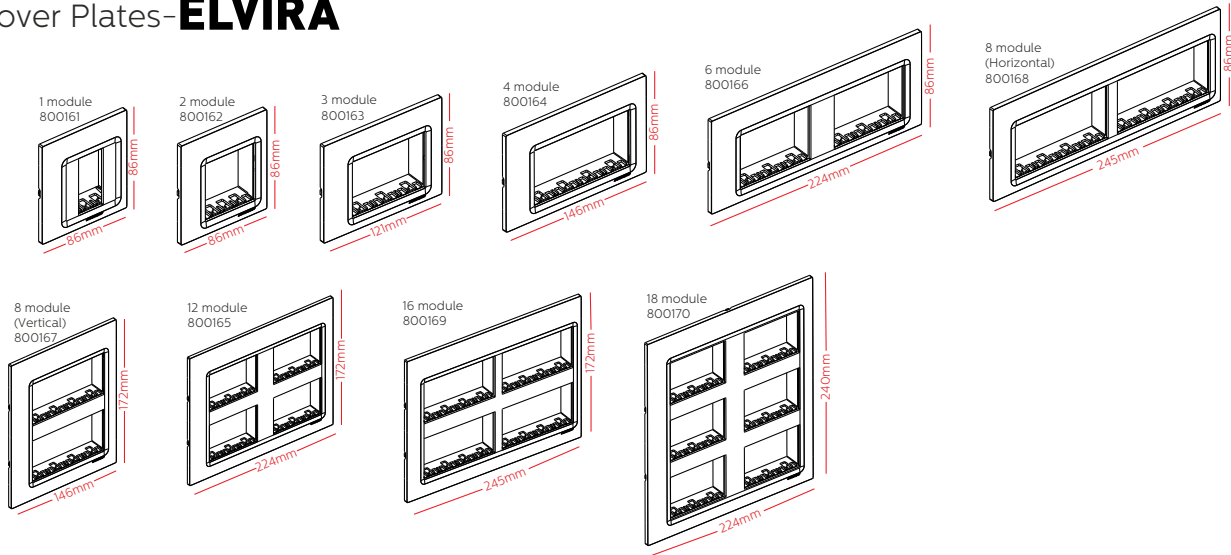

Flush Boxes-Metal

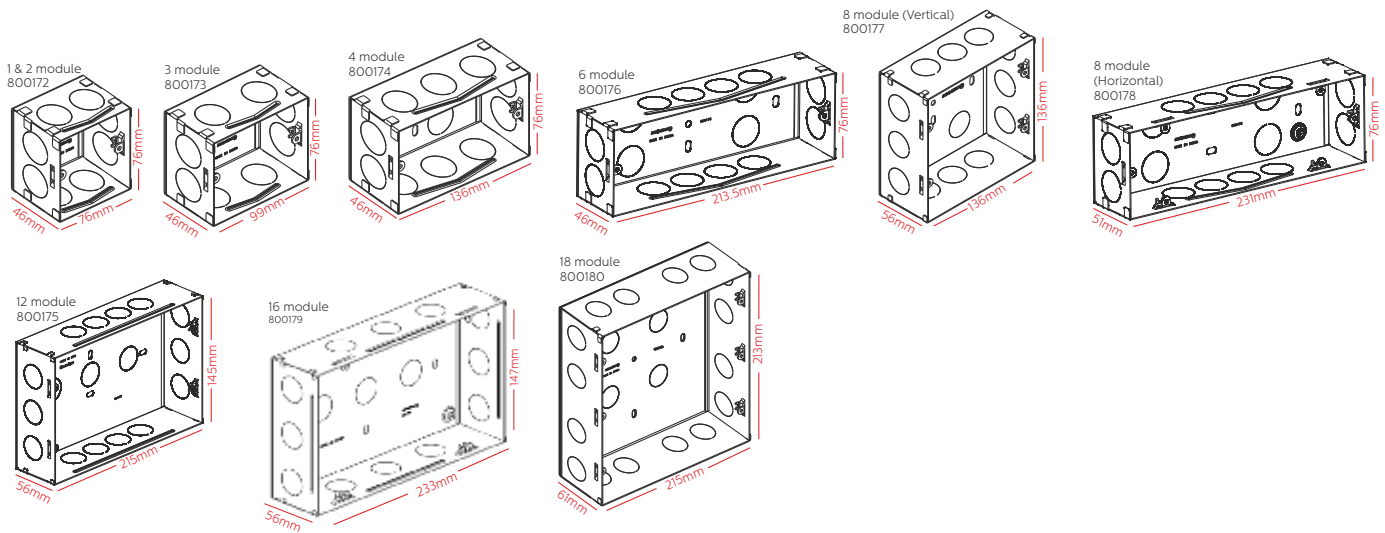

Surface Boxes-Plastic

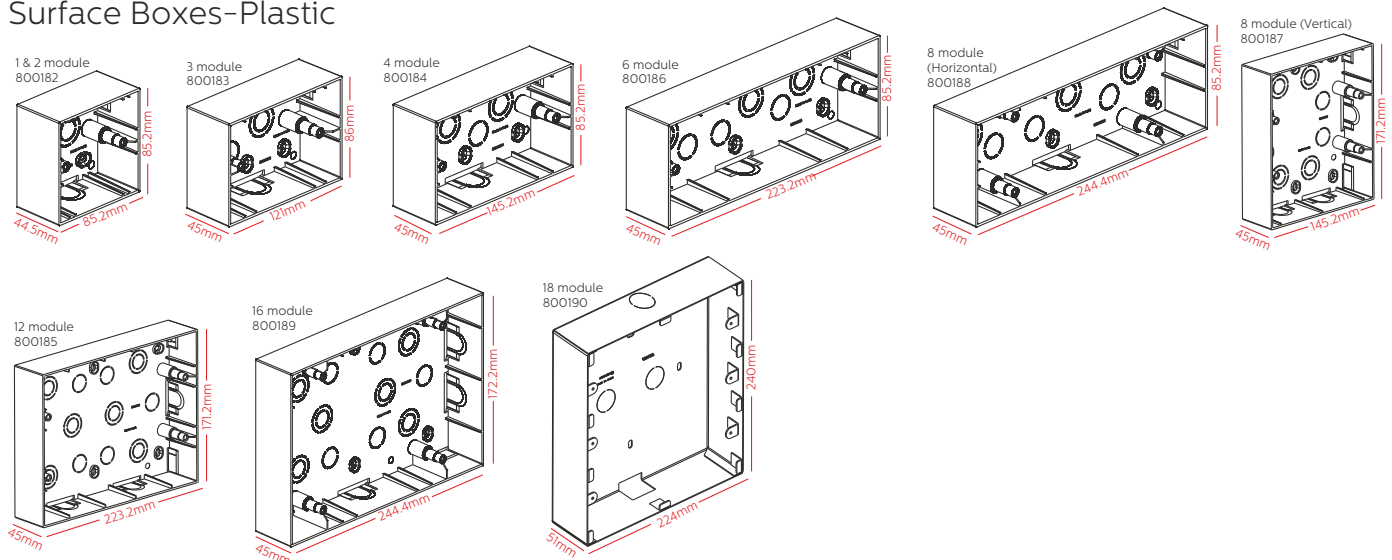

Where design meets safety



Scan to know more about the product

Doorsta doorbells are designed for clear sound. Built with high quality components, they provide dependable performance for residential and commercial spaces.

Features

- Made in India - BIS & RoHS compliant doorbell build for environmental safe usage
- Over current protection for consistent performance; works on 240 V AC
- Clear and audible chime for easy notification

Benefits

- Enhances safety for your home with stylish design
- Easy installation and operation
- Reliable performance for everyday use

Doorsta

Ding Dong Doorbell

• High Sound Output • BIS / RoHS Compliant • With Over Current Protection

HSN Code: 8536



Cat. Nos.	Description	MRP ₹ / Unit	Pack
698450	Doorsta Ding Dong Doorbell (BIS)	466	1/20
698451	Doorsta Ding Dong Doorbell (BIS)	492	1/20

3 Pin Plugs With Easy Grip

• White Matt Finish • ISI Marked

HSN Code: 8536



Cat. Nos.	Description	MRP ₹ / Unit	Pack
698470	6A 3 Pin Plug (ISI mark)	108	20/200
698471	16A 3 Pin Plug (ISI mark)	162	10/100

A range to match your needs



Scan to know more
about the product

Zosta exhaust and axial fans are designed for efficient ventilation & quiet operation ensuring calm and comfortable environment.

Features

- Aerodynamic blade design for high air delivery and efficient airflow
- Powerful copper motor for better current carrying capacity and longer life
- RoHS compliant construction
- Silent operation

Benefits





- Improves air quality by quickly removing smoke, fumes and odours
- Long lasting durability with rust free plastic body
- Offers hassle free installation & maintenance

Zosta™

Exhaust Fan - White / Black

• Copper Motor • RoHS Compliant • Rust Free Body • Silent Operation



HSN Code: 8536

	Cat. Nos.	Description	MRP ₹ / Unit	Pack
 698500	698500	Exhaust Fan 150mm White	2438	1/6
 698501	698501	Exhaust Fan 200mm White	2732	1/6
 698502	698502	Exhaust Fan 250mm White	3120	1/6
 698503	698503	Exhaust Fan 150mm Black	2438	1/6
 698504	698504	Exhaust Fan 200mm Black	2732	1/6
 698505	698505	Exhaust Fan 250mm Black	3120	1/6

Axial Exhaust Fan - White

• Copper Motor • RoHS Compliant • Rust Free Body • Silent Operation

HSN Code: 8536

	Cat. Nos.	Description	MRP ₹ / Unit	Pack
 698506	698506	Axial Exhaust Fan 100mm White	1718	1/20
 698507	698507	Axial Exhaust Fan 150mm White	1876	1/20

Bright ideas for
happy & safe living



Scan to know more
about the product

Bulb Holders are designed to provide a secure connection point for ceiling mounted lighting fixtures. Crafted from tough and lightweight material, it ensures durability while maintaining an attractive finish.

Features

- Long lasting polycarbonate plastic
- Ducts for heat dissipation
- Metal ring prevents deformation from overheating
- ISI certified bulb holders. All products are RoHS compliant

Benefits

- Ensures safe electrical connections for ceiling light fixtures
- Enhances aesthetics through glossy, dust resistant white finish
- Quick and easy installation

BULB HOLDER & CEILING ROSE

Fancy Batten Bulb Holder / Ceiling Rose

• Dynamic Design • Metal Ring Avoids Deformation

HSN Code: 8536

	Cat. Nos.	Description	MRP ₹ / Unit	Pack
 <p>698473 698474 698475</p>	698473	Fancy Batten Bulb Holder White (ISI mark)	90	20/200
	698474	Fancy Angle Bulb Holder White (ISI mark)	90	20/200
	698475	Fancy Ceiling Rose White	58	20/200

GENERAL TERMS

- This price list supersedes all previous price lists.
- All prices are in Indian Rupees only.
- All prices are Maximum Retail Prices (MRP) inclusive of GST as applicable.
- Our discount structure is exclusive of GST
- Orders will be accepted in multiples of standard packing.
- Prices are subject to change without notice. All despatches will be as per prices prevailing on the date of despatch. Prices are ex-godown, exclusive of packing/forwarding/freight and insurance.
- Product design is subject to change without notice for continuous up gradation.
- Disputes if any are subject to Delhi Jurisdiction only.
- Company reserves the right to issue amendments which may arise due to any printing errors in the price list.

WARRANTY

IA products carry a warranty against manufacturing defects, subject to use of the product for the right application, with correct wiring/connection and normal operating conditions. Please refer to detailed IndoAsian warranty policy effective 1st Jan 2026.

MCBs	36 Months
RCCBs	36 Months
DBs/ACCL	12 Months
HRC Fuses	6 Months
MCCBs/BFF/Fuse Bases/Changeover Switchgears/SDF	12 Months
Time Switches	12 Months
For Wiring Devices - Switches & Socket	120 Months
Bulb Holder/Ceiling Rose	12 Months
For Wiring Devices - Electronic Products (e.g. Fan Regulator, Dimmer, Buzzer, RJ45, RJ11 & TV Sockets, Bell Indicator, Motor starter, Skirting light)	24 Months

CHANNEL PARTNER



CORPORATE OFFICE: V. J. Business Towers, A-6, 1st Floor, Sector-125, Noida-201301, U.P., India.

CORPORATE OFFICE: V. J. Business Towers, A-6, 1st Floor, Sector-125, Noida-201301, U.P., India. Ph.: +91-0120-3305111 E-mail: customer.care@indoasian.com, international@indoasian.com Website: www.indoasian.com

CUSTOMER CARE HEAD: Novateur Electrical & Digital Systems Pvt. Ltd., V. J. Business Towers, A-6, 1st Floor, Sector-125, Noida-201301, U.P., India. Ph.: +91-0120-3305100 Toll Free no. 1800 103 7077 E-mail: customer.care@indoasian.com

NORTH

Regional Sales office
DELHI NCR
V. J. Business Towers
A-6, Ground Floor,
Sector-125, Noida-201303
Ph.: 0120-6858900

Branch office
CHANDIGARH
SCO No. 6, 2nd Floor,
Madhya Marg, Sector 26,
Chandigarh-160019

Branch office
JAIPUR
433, 4th Floor, Ganpati Plaza,
M. I. Road,
Jaipur-302001
Ph.: 0141-4113528

Branch office
LUCKNOW
107 B&C, 1st Floor, Ratan Square
20-A Vidhan Sabha Marg,
Lucknow-226001
Ph.: 0522-4013210

SOUTH

Regional Sales office
BANGALORE
787, 1st Floor "Skyline Vista" 15th Cross,
100 Feet Ring Road, J P Nagar 1st Phase,
Bangalore-560 078
Tel: 080-46219999
E-Mail: in-bangalore-office@indoasian.com

Branch office
COCHIN
Door No.65/1317, Syda Building, 2nd Floor,
Kaloor-Kadavanthra Road, Kaloor,
Ernakulam District, Kochi-682017 (Kerala)
Ph.: 0484-4055581-88
E-Mail: in-cochin-office@indoasian.com

Branch office
COIMBATORE
Door No. 83,
Dr. Nanjappa Road,
Coimbatore-641018
Ph.: 0422-2302715
E-Mail: in-coimbatore-office@indoasian.com

Branch office
CHENNAI
No.5, 1st Floor, Mahalingapuram Main Road,
Nungambakkam,
Chennai-600034
Ph.: 044-28172096, 28170527
E-Mail: in-chennai-office@indoasian.com

Branch office
HYDERABAD
312, 3rd Floor,
Amrutha Estates, Himayath Nagar,
Hyderabad-500029
Ph.: 040-66742425
E-Mail: in-secunderabad-office@indoasian.com

WEST

Regional Sales office
MUMBAI
401 & 408, K.P. Arrum,
Marol Maroshi Road, Andheri East,
Mumbai-400059
Ph.: 022-61035800
E-Mail: in-mumbai-office@indoasian.com

Branch office
AHMEDABAD
102, 1st Floor, Shivalik High Street,
Near Mansi Circle, Vastrapur,
Ahmedabad-380015
Ph.: 079-29701351-53
E-Mail: in-ahmedabad-office@indoasian.com

Branch office
INDORE
Tower B, 403 - The One
Ravindra Nath Tagore Marg,
Indore- 452001
Ph.: 0731-4677510
E-Mail: in-indore-office@indoasian.com

Branch office
PUNE
311, Pride Silicon Plaza, Bhamburda,
Shivaji Nagar, Senapati Bapat Marg,
Pune-411016
Ph.: 8087610722
E-Mail: in-pune-office@indoasian.com

EAST

Regional Sales office
KOLKATA
"Raikva Building" Room No. 8, 2nd Floor,
3A Ram Mohan Garden Lane, Beliaghata E.M.Bypass,
Kolkata-700010
Ph.: 033-66041503
E-Mail: in-kolkata-office@indoasian.com